

2022MY BRZ Short Throw Shifter Port Installation Instructions

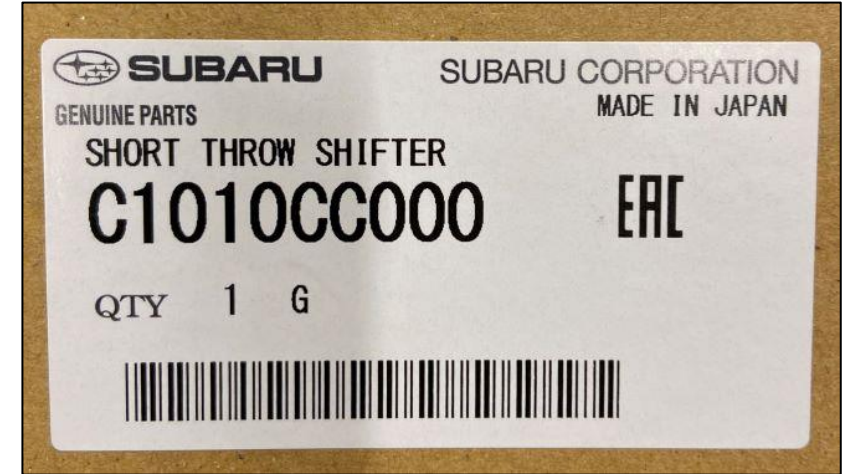

Ensure the VIN matches the work order, the vehicle due date is in the lock period, and verify there are no "Holds" on the vehicle for any reason. Verify the vehicle calls for the accessory installation.



CAUTION: ACCESSORY INSTALLATIONS PERFORMED BY UNTRAINED PERSONS COULD RESULT IN SERIOUS INJURY TO THOSE PERSONS OR TO OTHERS. Subaru Work Instructions are intended for use by professional accessory installers ONLY. They are written to provide step by step accessory installation instruction for a fast-paced production environment. Properly trained accessory installers have the equipment, tools, safety instructions and know-how to do the job correctly and safely. Included in this information are the use of "special" accessory installation fixtures and templates that are not available to the Retailers or general public. Please refer to the Retailer Installation Instructions found in Subaru Tech Info System (STIS).

SUBARU OF AMERICA, INC. IS "ISO 14001 COMPLIANT"
The international standard for excellence in Environmental Management Systems. Please recycle or dispose of automotive products in a manner that is friendly to our environment and in accordance with all local, state and federal laws and regulations.

2022MY BRZ Short Throw Shifter Port Installation Instructions

BRZ Battery Disconnection



Open the hood and use the prop rod to hold the hood open. Using a ¼" drive ratchet and 12mm socket remove the negative battery cable from the negative battery stud. Do not remove negative cable from the battery post. Position / protect the negative cable so it cannot accidentally touch body ground or the negative battery terminal. Allow (60) seconds before the next installation step to ensure the airbag power supply is discharged.

⚠ Carefully remove the negative battery cable from the battery stud only. Do not allow the negative cable accidentally ground during the installation.







2022MY BRZ Short Throw Shifter Port Installation Instructions

Inspect the Short Throw Shifter Kit for damage, defects, or missing items

Kit Contents

- (1) Short Throw Shifter Assembly.
- (1) Shifter Linkage Cover boot.
- (1) Retaining Ring.



	STOP <u>Stop</u> : Damage may occur to the vehicle/part. Do not proceed until process has been complied with.
	WHA <u>Work Hazard Analysis (WHA)</u> : Operator safety-Use caution to avoid risk of injury.
	Caution : A process that must be carefully observed in order to reduce the risk of damage to the accessory/vehicle and to ensure a quality installation.
	Revision Mark/Highlight : This mark highlights a change in installation with respect to the previous issue.
	WIT <u>Work Instruction Training (WIT)</u> : Key point that designates an important step to ensure the quality of the installation.
	Recycle : Item to be recycled.
	Safety Torque - This mark indicates that a torque is related to safety

2022MY BRZ Short Throw Shifter Port Installation Instructions

OE and Accessory Short Throw Shifter Identification

- We highly recommend marking the accessory short throw shifter with the metal marker to prevent mixing up with the OE Shifter.
- See the measured differences between the O.E. Shifter and the accessory short throw shifter.



Mark Here with a metal marker.

Difference between OE Shifter assembly compared to the Accessory Short Throw Shifter

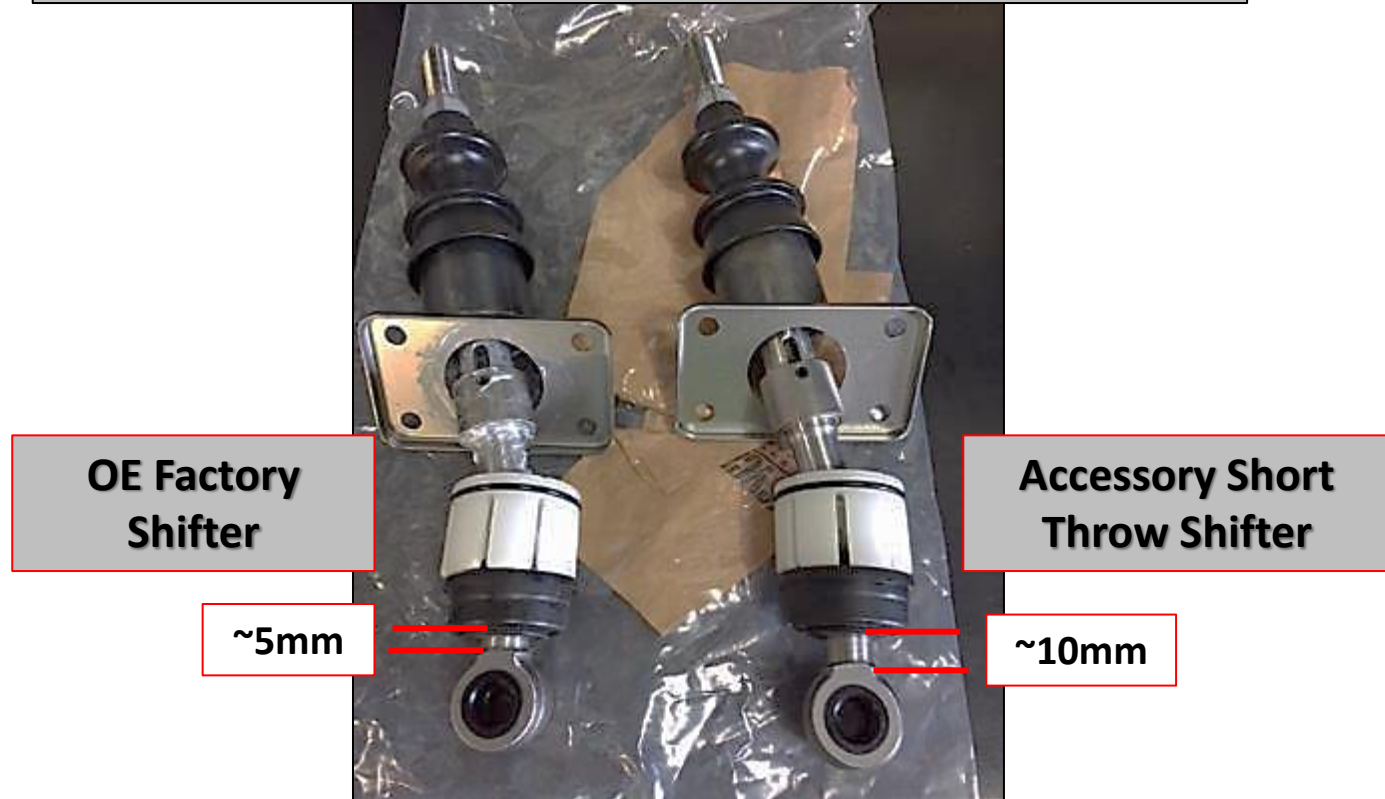

WIT We highly recommend marking the Accessory Short Throw Shifter with the metal marker to prevent mixing up with the OE Shifter.

2022MY BRZ Short Throw Shifter Port Installation Instructions

Required Tools and Equipment

Required tools:

- #2 Phillips Screwdriver
- Flat Blade Screwdriver (Not Shown)
- Nylon Trim Tool
- 1/4" dr. Torque Wrench
- 1/4" dr. Ratchet
- 1/4" dr. 10mm, and 12mm sockets. (Magnetic)
- 1/4" dr. Short and Long Extensions.
- External Retaining Ring Plier, Tip Angle: 90°.
- Vehicle protection
- Masking Tape
- Torque Marker
- Plastic Feeler Gauge 2.0mm
- Flashlight (Not Shown)
- White Lithium Grease (Example: Jet-Lube www.jet-lube.com) or similar product



2022MY BRZ Short Throw Shifter Port Installation Instructions

Preparation

1. Engage the parking brake.
 - *Do not apply excessive force that can damage the parking brake and components.*



 **Do not apply excessive force. Damage to the parking brake and/or components may result.**

2022MY BRZ Short Throw Shifter Port Installation Instructions

Shifter Boot / Panel Removal

1. Install interior vehicle protection to cover the audio head unit display.
2. Apply protective masking tape on the sides and lower edge of the trim panel below the HVAC control panel.
3. Remove the parking brake boot / trim by pulling straight up to disengage the (5) retaining clips, then carefully slide the boot over the parking brake handle.
➤ Place the boot / trim panel aside on a clean protected surface for reinstallation.



2022MY BRZ Short Throw Shifter Port Installation Instructions

Shifter Boot / Panel Removal

1. Using a nylon trim tool, carefully remove the lower trim panel below the HVAC controls.
2. Remove the (2) #2 Phillips screws shown, securing the shifter bezel trim panel.
3. Carefully remove the shifter bezel trim by pulling up and out to disengage the (12) retaining clips.
➤ Place the bezel trim aside for reinstallation.

 Take care not to damage or scratch any panels during removal.



2022MY BRZ Short Throw Shifter Port Installation Instructions

Shifter Boot / Panel Removal

1. Remove the OE shift knob by unscrewing it in a counterclockwise direction
 2. Remove the shifter boot trim by pulling up and carefully working the boot up and off the shifter handle.
- Place the shift knob and boot trim aside for reinstallation.

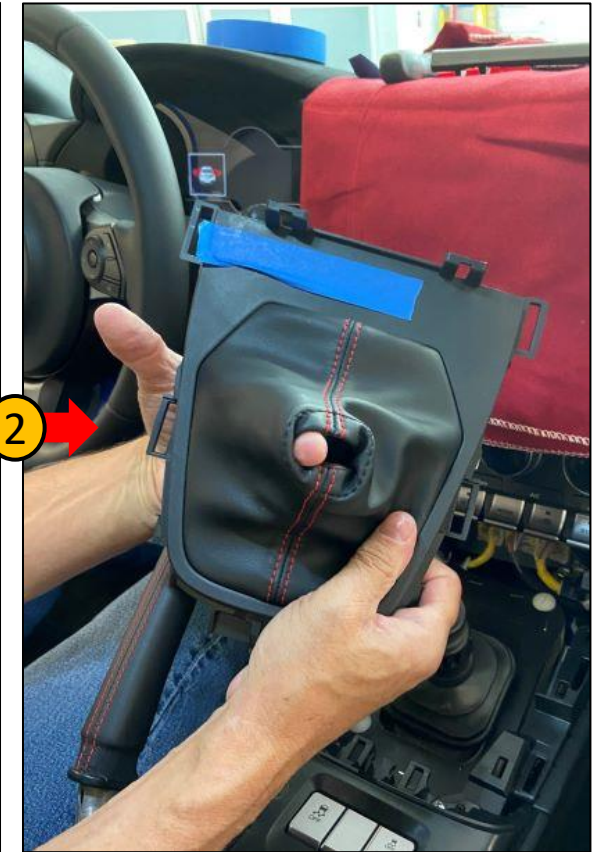
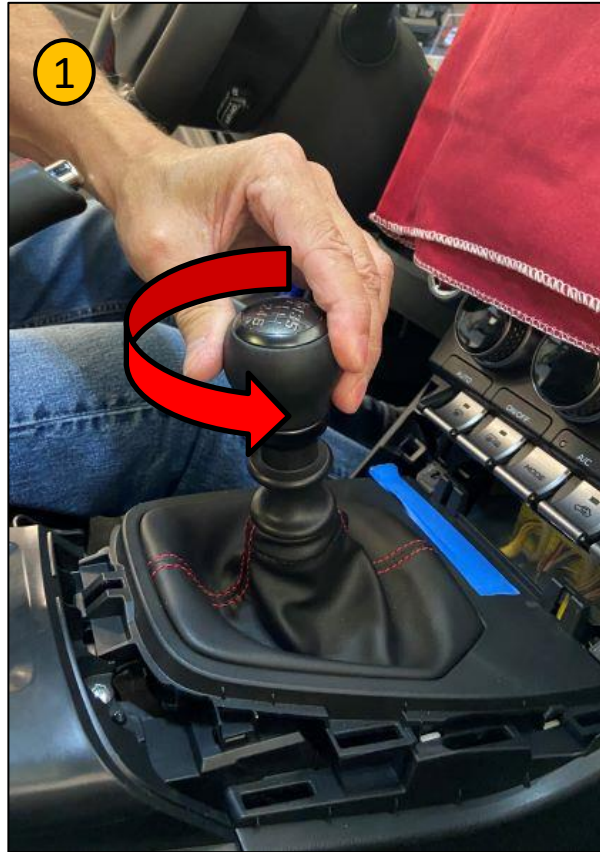

Take care not to damage or scratch any panels during removal.



2022MY BRZ Short Throw Shifter Port Installation Instructions

Shifter Boot / Panel Removal

1. Remove the (2) foam insulator clips by hand and store. Note: if the clips are tight, use a flat blade screwdriver to loosen the clips.
2. Remove the foam insulator by carefully working the insulator up and off the shifter handle.
 - Place the foam insulator aside for reinstallation.
3. Release the wire harness holder clip from the right side of the shifter plate.

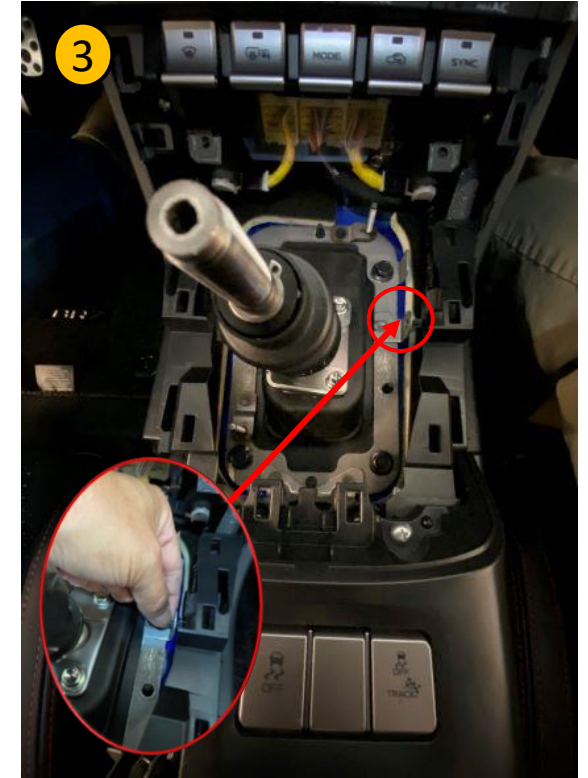

2022MY BRZ Short Throw Shifter Port Installation Instructions

Center Console box Removal

1. Remove the (2) #2 Phillips screws shown from the front of the center console box.
 2. Adjust the LF seat to the full forward position for access to the rear console box area and remove the bolt cover with a plastic trim tool.
 3. Using a ¼" drive ratchet with 6" extension and 10mm socket, remove the 10mm bolt. Save bolt for reuse.
- (Repeat sequence on the RH side of the vehicle.)

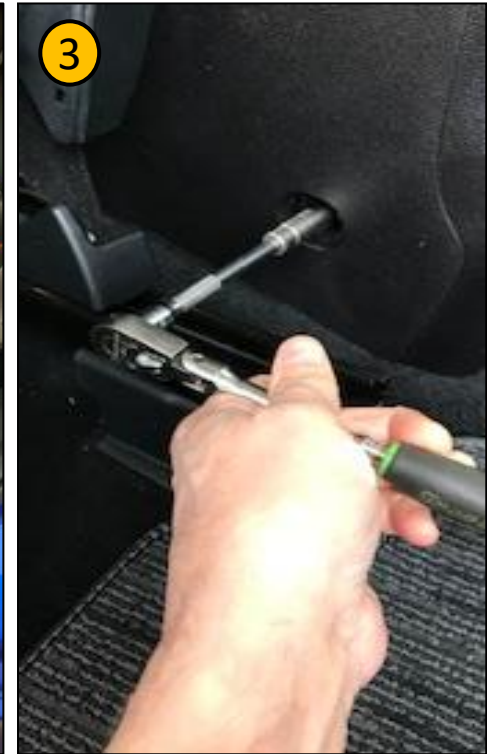
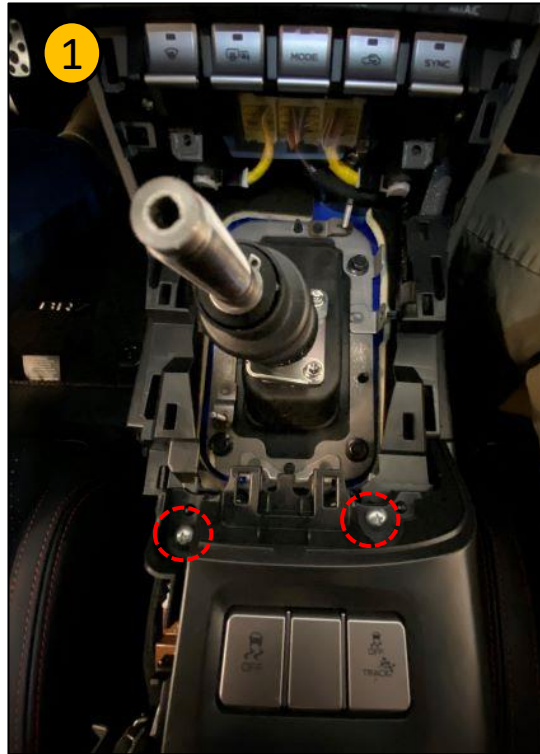

2022MY BRZ Short Throw Shifter Port Installation Instructions

Center Console box Removal

1. Return both front seats to the upright rear position.
2. Lift the front of the console box and disconnect the (2) electrical connectors shown.
3. Remove the center console box assembly and set aside on a clean protected surface.



Take care not to damage or scratch any panels during removal.

2022MY BRZ Short Throw Shifter Port Installation Instructions

Side Trim Panel Removal

1. Remove the (2) #2 Phillips screws shown from the front of the rear of the side panels.
2. Release and separate the rear side trim panels.
3. Remove the LH side trim panel by pulling rearward to release the front of the panel. (Set the panel aside for reinstallation)
4. Release the front of the RH side panel by pulling rearward and move it to the side for shifter plate access.

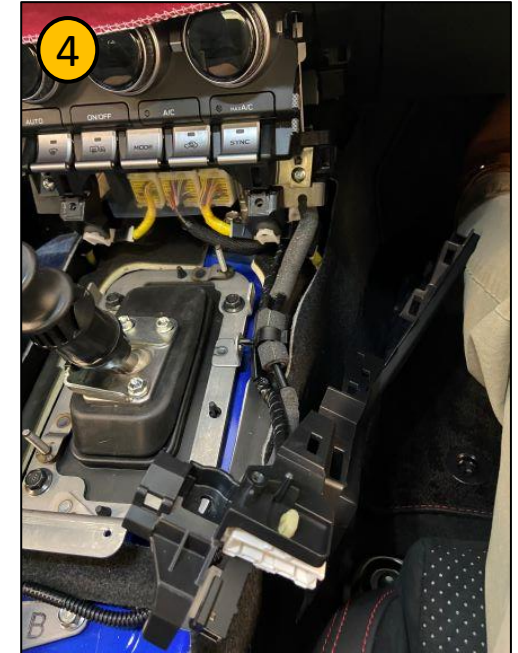
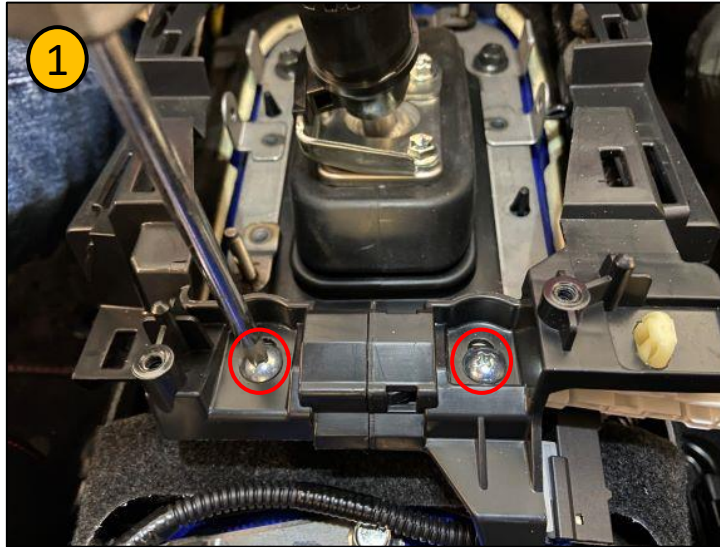

Take care not to damage or scratch any panels during removal.

2022MY BRZ Short Throw Shifter Port Installation Instructions

O.E. Shifter Assembly Removal

1. Using a 12mm socket and ratchet with an extension remove (4) 12mm shoulder bolts that retain the shifter plate.
2. Remove the shifter plate by carefully pushing the (4) shifter boot alignment tabs out of the shifter plate alignment holes.
➤ Place the shifter plate aside for reinstallation.

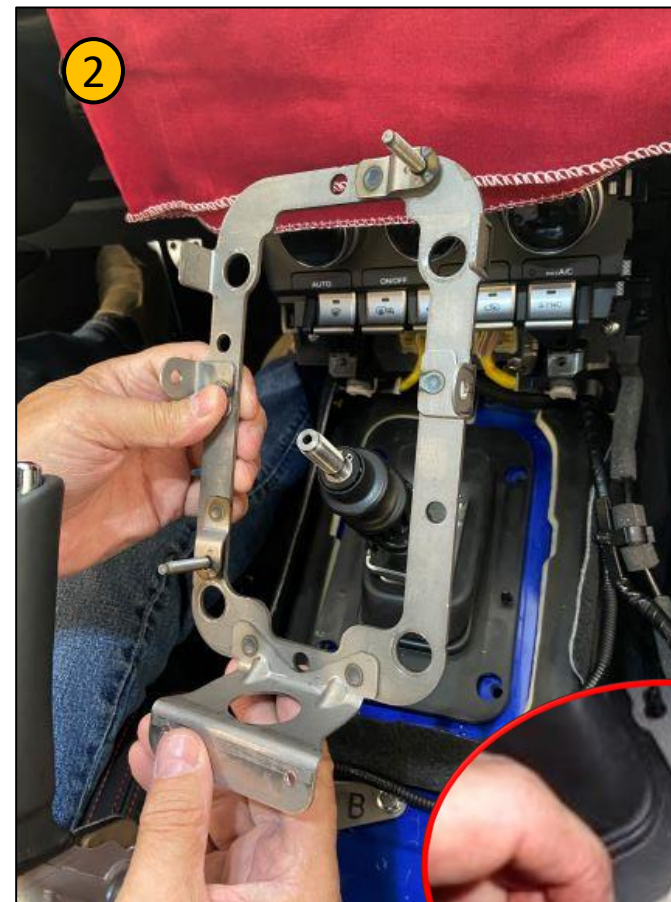
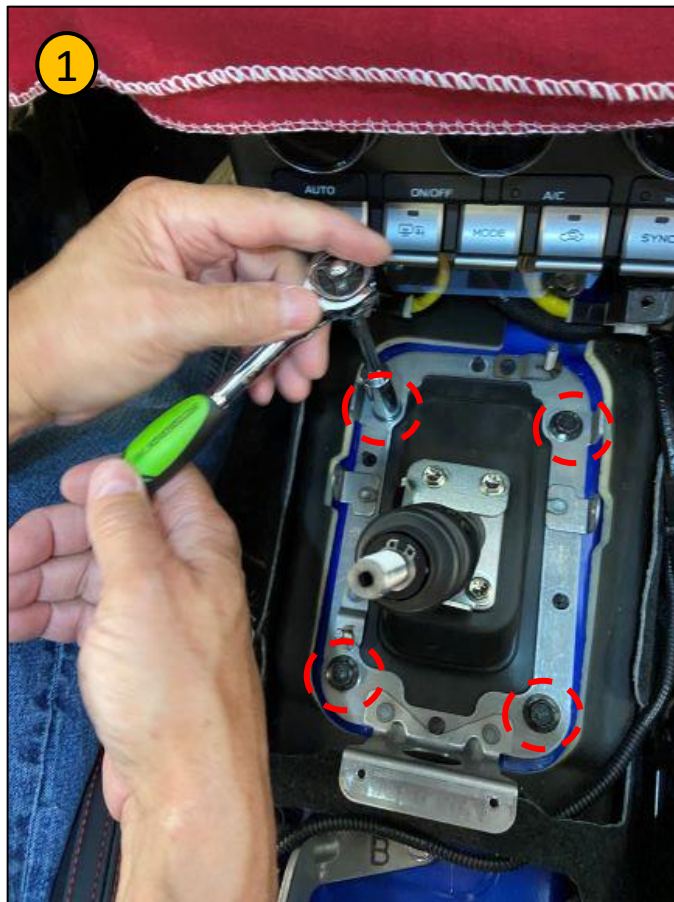

Be careful not to damage the (2) shifter boot alignment tabs.



2022MY BRZ Short Throw Shifter Port Installation Instructions

O.E. Shifter Assembly Removal

1. Remove the shifter boot by carefully pulling the boot over the reverse lock-out plate and shifter handle. Set the shifter boot aside for reinstallation.
2. Using a 10mm socket, ratchet and extension remove the (3) bolts that retain the O.E. shifter base plate and the reverse lock-out plate.
3. Remove the lock-out plate and set aside with (3) bolts for reinstallation.

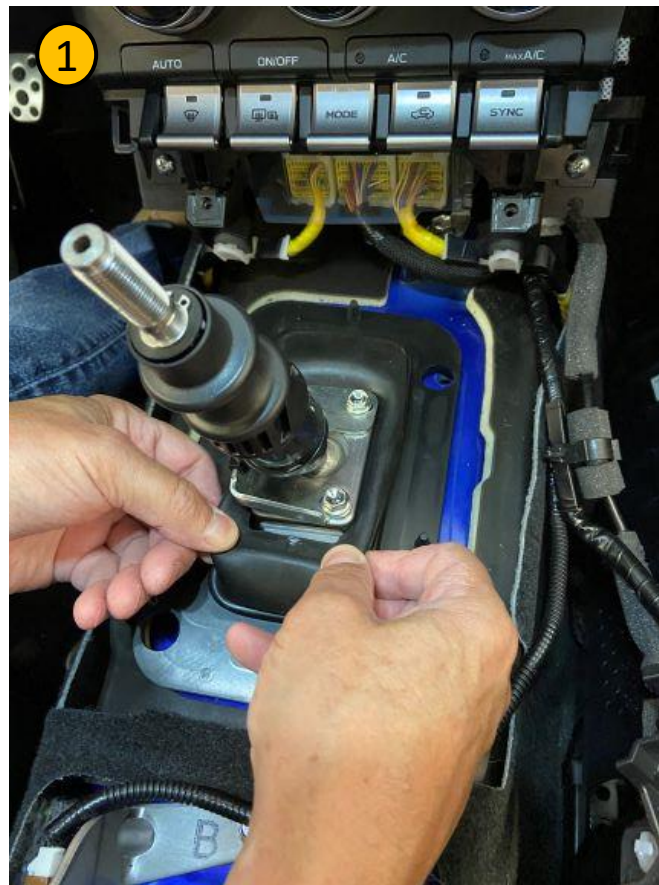

Be careful not to damage (tear) the shifter boot.

2022MY BRZ Short Throw Shifter Port Installation Instructions

O.E. Shifter Assembly Removal

1. Carefully dislodge (move) the shifter linkage boot to access the shifter linkage rod from the transmission.
2. Using 90° retaining ring pliers, carefully remove the retaining ring and the washer from the linkage rod.
3. Properly dispose of the retaining ring.  **Place the washer aside for reinstallation.**
4. Disconnect the linkage rod by pushing out of the shifter bushing.

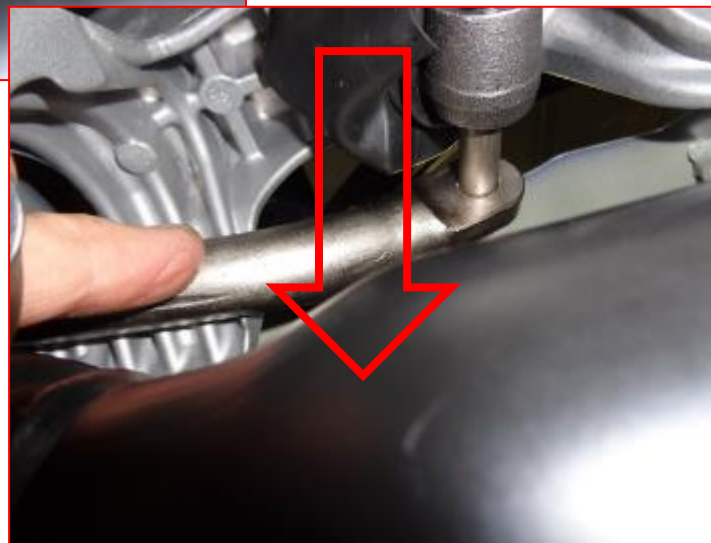
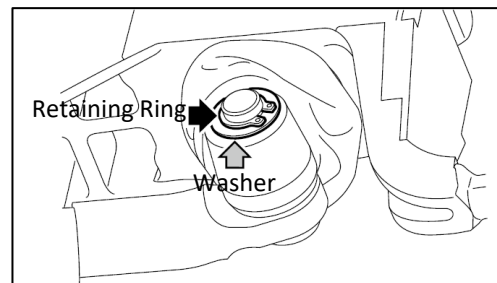

⚠ Note: The shift linkage and shifter linkage boot was removed from the linkage rod and photographed under the vehicle to enhance the pictures.

2022MY BRZ Short Throw Shifter Port Installation Instructions

O.E. Shifter Assembly Removal

1. Remove the O.E. Shifter assembly with O.E. shift linkage boot by pulling straight up and out of the shifter holder.
➤  Please recycle the removed O.E. shifter assembly and shifter linkage boot responsibly.



2022MY BRZ Short Throw Shifter Port Installation Instructions

Short Throw Shifter Assembly Installation

1. Carefully feed the new shift linkage boot around the Short Throw shifter linkage base using the small hole as shown.
2. Carefully position the shifter base with shift linkage boot into the hole in the shifter holder assembly.
3. Ensure the shifter is fully seated in the holder and the linkage boot is not trapped by the shift holder. (See next slide for installation tips)
4. Position the shifter retaining plate in place on the shifter holder and temporarily install (2) bolts hand tight to hold shifter secure during linkage and linkage boot installation.



Be careful not to tear or damage the shift linkage boot when installing on Short Throw shifter linkage base or installing the shifter into the shift holder assembly.

2022MY BRZ Short Throw Shifter Port Installation Instructions

Short Throw Shifter Assembly Installation Tip

1. Carefully position the Short Throw linkage boot by using your fingers to guide the bottom of the boot in place to allow the Short Throw Shifter ball and socket to stay in proper position.
2. Be careful not to push down with excessive force on the Short Throw Shifter when installing into the holder assembly. Too much downward force can result in dislodging the ball from the socket. The shifter will feel very limp in place. This will require the Short Throw Shifter assembly to be removed to re-position the ball in the socket assembly and re-install again.



OK Shifter ball and socket in correct position.

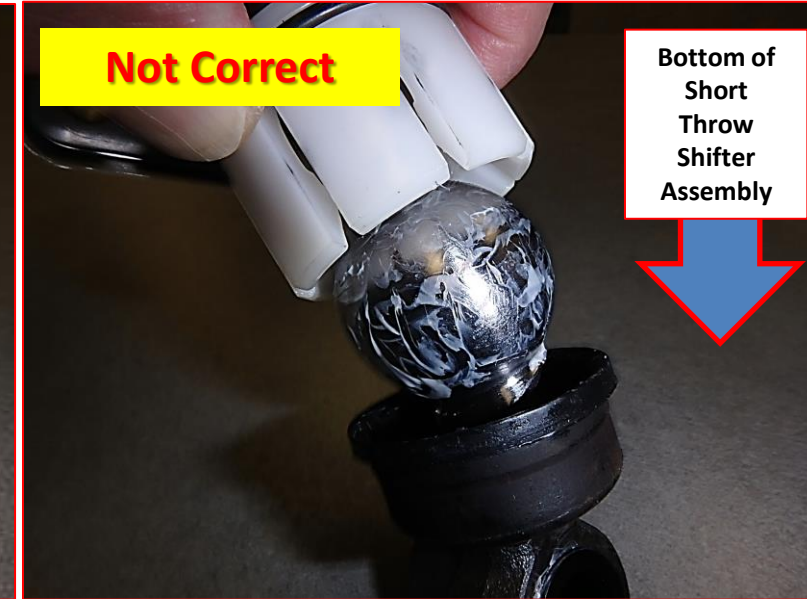

Not OK Shifter ball and socket are not in the correct position.

STOP Be careful not to push down with excessive force on the Short Throw Shifter when installing into the holder assembly. Too much downward force can result in dislodging the ball from the socket. The shifter will feel very limp in place. This will require the Short Throw Shifter to be removed to reset the ball in the socket assembly and re-install.

2022MY BRZ Short Throw Shifter Port Installation Instructions

STI Shifter Assembly Installation

- **TIP:** Place the shifter in the 4th gear position for improved linkage access.
- 1. Position the shift linkage boot with the large opening around the shifter rod end.
- 2. Apply white lithium grease to the linkage rod joint to bushing.
- 3. Reconnect the linkage rod by pushing it into the shifter base.
- 4. Carefully reinstall the OE washer and new retaining ring. **(See caution statements)**
- 5. Reposition the shift linkage boot over the shift linkage. Do not tear the boot.



Apply White Lithium grease here.



⚠ Note the correct orientation of the linkage washer.

Note: The washer is a conical design. The cone shape goes outward

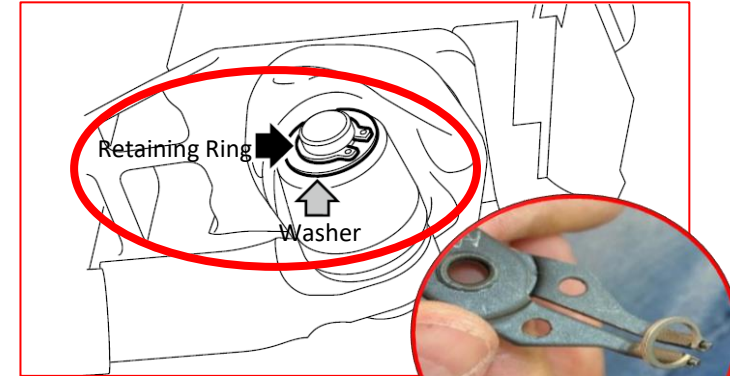

⚠ Warning: ⚠

Open the snap ring as little as possible during installation. Opening the snap ring too far will deform its shape, posing risk of ring detachment and linkage failure.

After attaching snap ring ensure:

- ✓ The snap ring is fully seated in the groove.
- ✓ There is no looseness present.
- ✓ Enough resistance is present, preventing the snap ring from rotating in the groove using your finger.

2022MY BRZ Short Throw Shifter Port Installation Instructions

Short Throw Shifter Assembly Installation

1. Remove the previously installed (2) bolts used to assist with linkage and boot installation then loosely install the shifter and reverse lock-out plate by hand installing the (3) 10mm bolts.

Locate 2nd Gear for Reverse Lock-out Adjustment



- a) Move the shifter all the way to the right and engage 5th gear.
- b) Move the shifter to engage 3rd gear.
- c) Move the shifter to engage 1st gear.
- d) Move the shifter to engage 2nd gear.
- e) **Repeat as necessary to ensure the transmission is in 2nd gear before moving to the next step.**



Locate 2nd Gear



2022MY BRZ Short Throw Shifter Port Installation Instructions

Short Throw Shifter Assembly Installation

1. Ensure the shifter assembly is properly seated in place.
2. Ensure the Lock-out plate is square and properly aligned with the shifter retaining plate .
3. Ensure the (3) 10mm bolts are hand tightened.
4. **Place the shifter in 2nd gear. (Refer to slide #25)**
5. **Using a 2.1 mm feeler gauge, position the reverse lock-out plate 2.1mm between the shifter detent.**
6. **Carefully torque the (3) 10mm bolts $T=7.5N\cdot m$ {77kgf·cm} {5.5ft·lbf} or 66 Inch Lbs.**
7. Torque mark the bolts.
8. Statically test the shifter by shifting through the (6) forward gears and Reverse using lock-out slide handle.



$T=7.5N\cdot m$ {5.5ft·lbf} or 66 Inch Lbs.

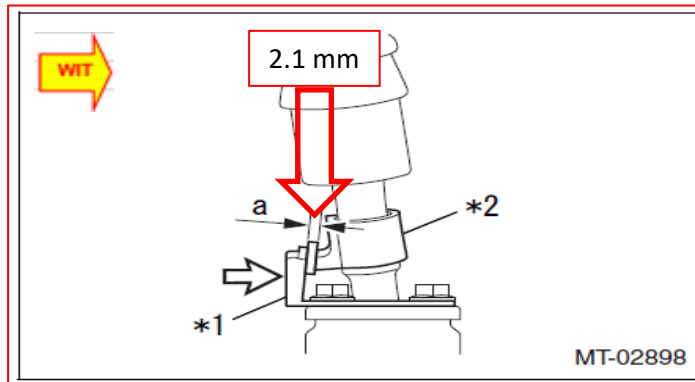

2.1 mm thickness



2022MY BRZ Short Throw Shifter Port Installation Instructions

Short Throw Shifter Assembly Installation

1. Carefully install the shifter boot over the shifter handle and base assembly. (Ensure the boot is properly positioned and fully seated)
 2. Re-install the shifter plate by carefully pushing the shifter boot alignment tabs through the shifter plate alignment holes.
 3. Install the (4) previously removed 12mm shoulder bolts and torque to 13.3 ft lbs.
- Torque mark bolts.

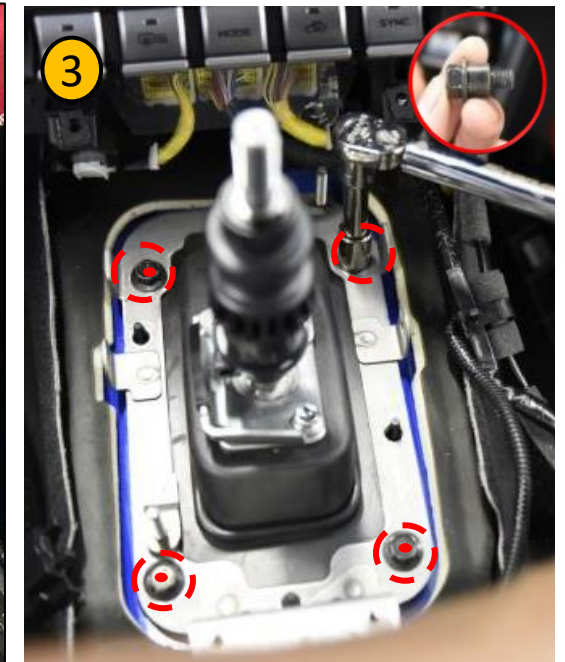
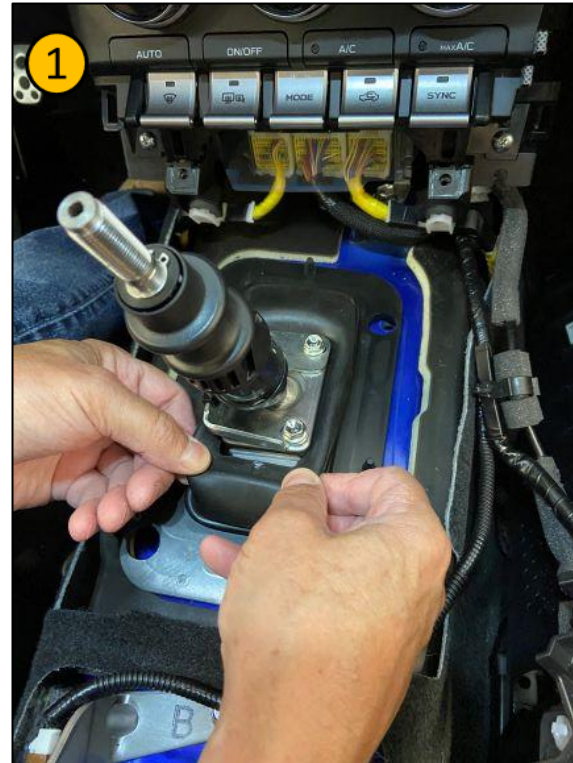

T=18N·m {13.3ft·lbf} or
159.6 Inch Lbs.



2022MY BRZ Short Throw Shifter Port Installation Instructions

Short Throw Shifter Assembly Installation

1. Re-install the LH side trim panel by aligning the front alignment tab and clip with the dash trim and sliding the panel forward.
2. Re-install the RH side trim panel by aligning the front alignment tab and clip with dash trim and sliding the panel forward.
3. Resecure the wiring harness clip into the right side of the shifter plate.
➤ Confirm the clip is locked in place.

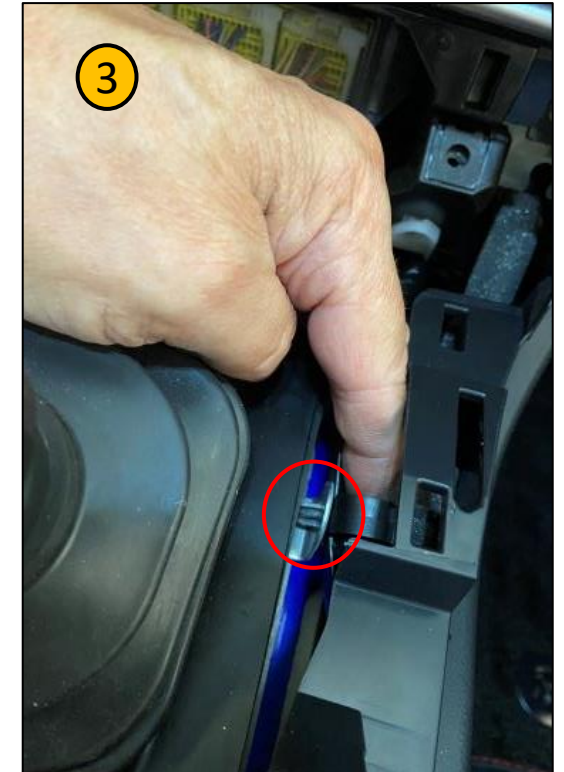
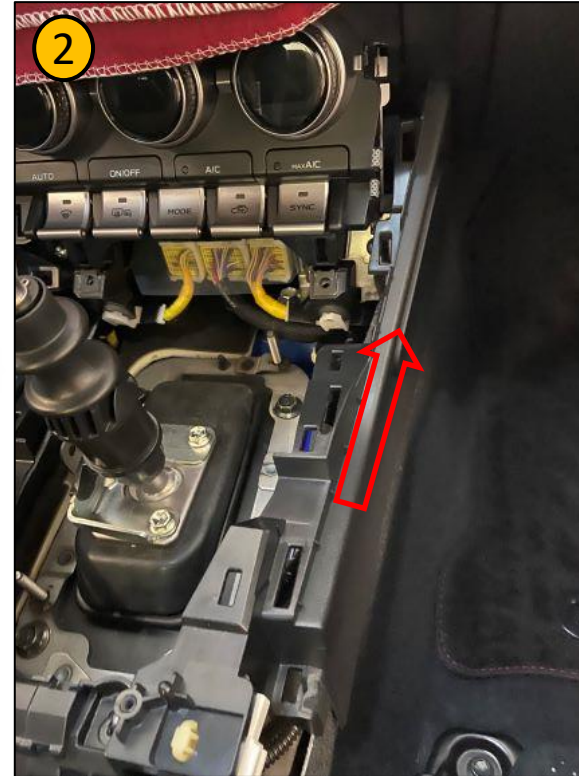

Take care not to damage or scratch any panels during reinstallation.



Ensure the wiring harness clip is properly installed and locked in place on the shifter plate.



2022MY BRZ Short Throw Shifter Port Installation Instructions

Short Throw Shifter Assembly Installation

1. Reinstall the foam insulator into position and install the (2) white foam insulator clips by hand. Do not over tighten.
2. Snap the rear side trim panels together. (Confirm panels are locked together with push pull method)
3. Reinstall the (2) #2 Phillips screws in the side trim panels that were previously removed. (Do not over tighten)

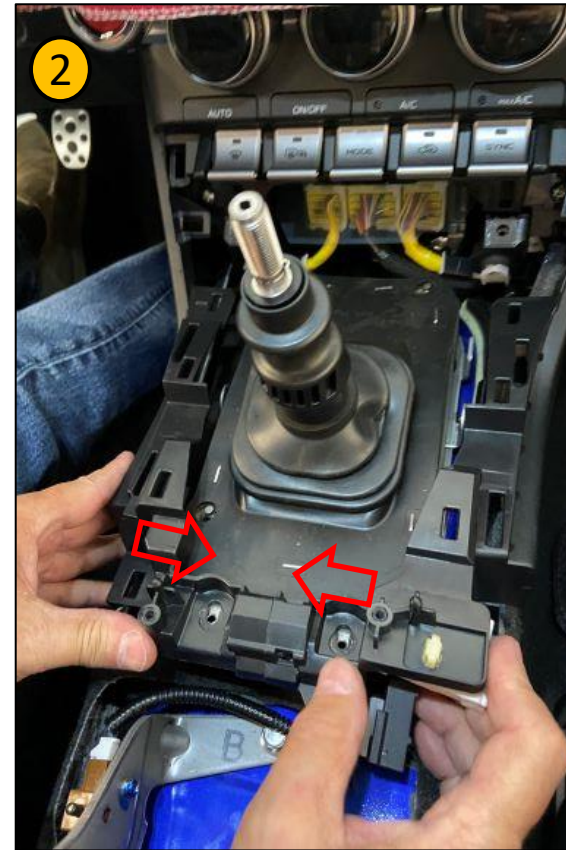

Take care not to damage or scratch any panels during reinstallation.

2022MY BRZ Short Throw Shifter Port Installation Instructions

Short Throw Shifter Assembly Installation

1. Place the center console box into position and reconnect the (2) wiring connectors previously disconnected. (Confirm proper connection with push pull method)
 2. Adjust the LF seat to the full forward position for access to the rear console box area.
 3. Using a ¼" drive ratchet with 6" extension and 10mm socket, install the 10mm bolt previously removed.
 4. Install bolt cover trim and adjust seat to rear position.
- Repeat steps 2-4 on RH side of then vehicle.

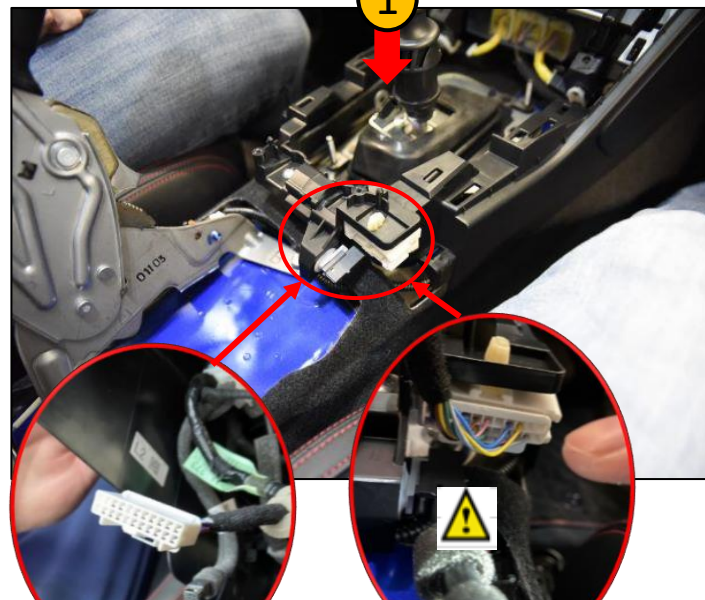

 **Confirm proper wiring connections.** 

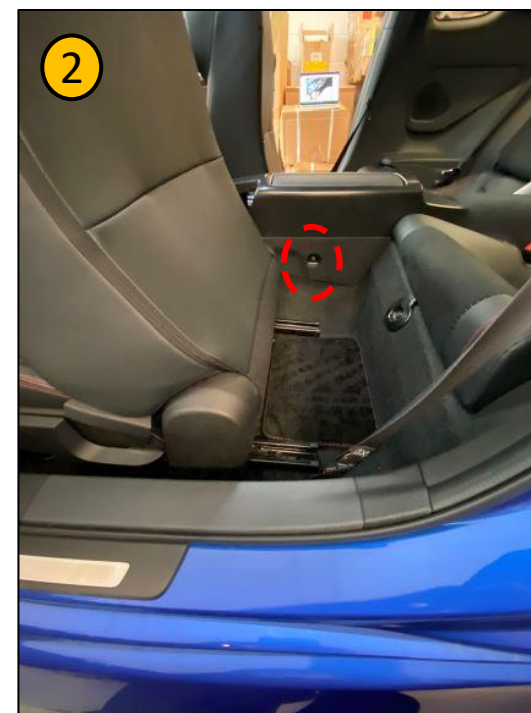

 **Take care not to damage or scratch any panels during reinstallation.**



2022MY BRZ Short Throw Shifter Port Installation Instructions

Short Throw Shifter Assembly Installation

1. Confirm proper seating of the center console and reinstall the (2) Phillips Head screws shown. Do not overtighten.
2. Reinstall the shifter boot trim by carefully working the boot over the shifter handle and fully seat clips. (Confirm proper seating of the boot at the base of the reverse lock-out handle)
3. Reinstall the OE shift knob by screwing it on in a clockwise direction.

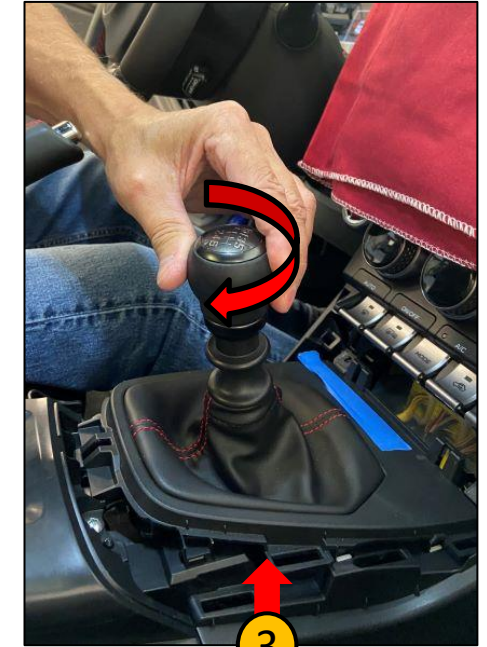
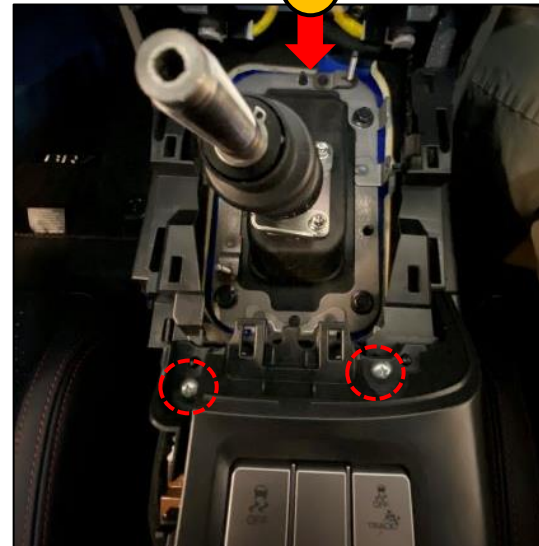
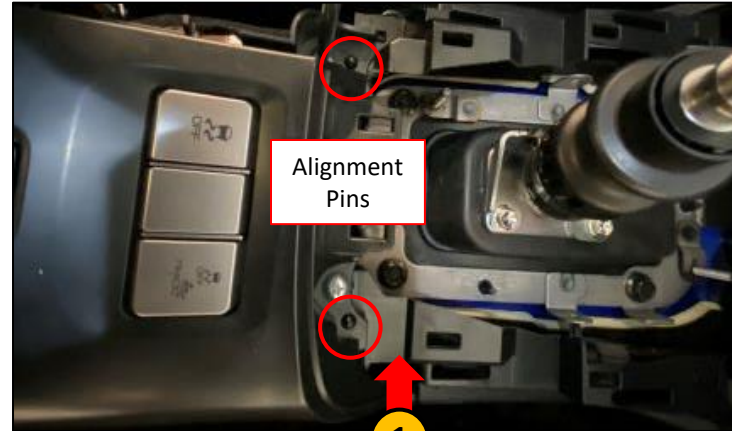

Take care not to damage or scratch any panels during reinstallation.



2022MY BRZ Short Throw Shifter Port Installation Instructions

Short Throw Shifter Assembly Installation

1. Reinstall the bezel trim by aligning the clips and applying pressure to fully seat trim panel.
2. Reinstall the (2) Phillips Head screws previously removed. Do not overtighten.
3. Align clips and reinstall trim panel below HVAC controls. (Confirm panel is fully seated)
4. Carefully work hand brake boot over handle, align clips, and reseat hand brake trim. (Confirm trim is fully seated)

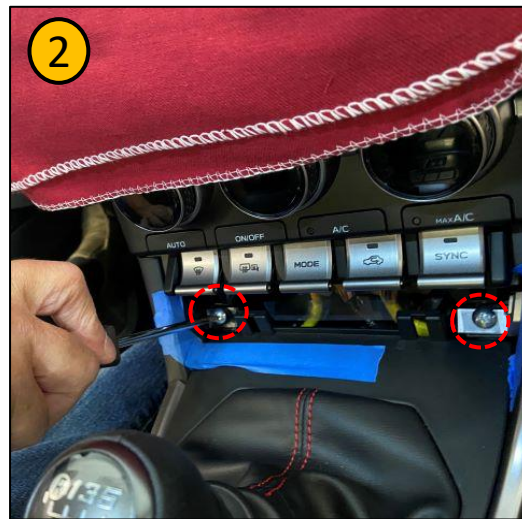
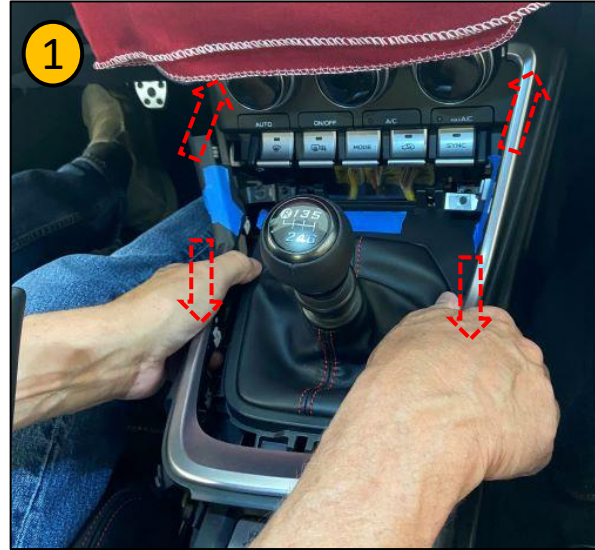

 **Take care not to damage or scratch any panels during reinstallation.**

2022MY BRZ Short Throw Shifter Port Installation Instructions

Short Throw Shifter Assembly Installation

1. Remove protective tape.
2. Remove interior protection.
3. Closely inspect the installation area for damage and confirm all trim panels are properly positioned and fully seated.

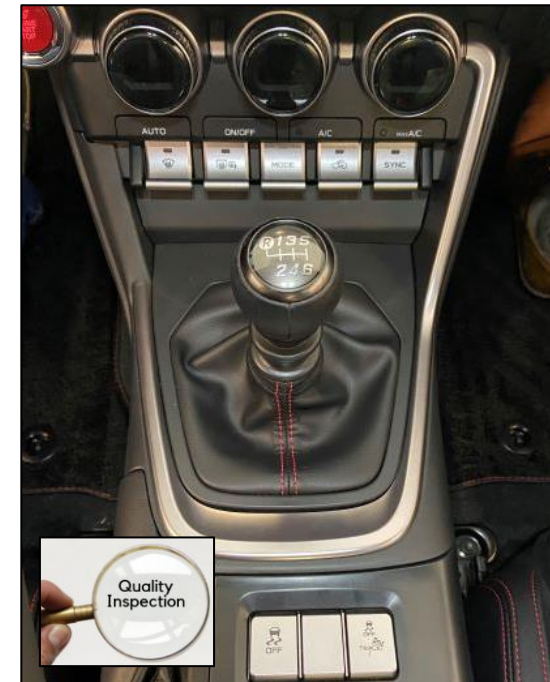
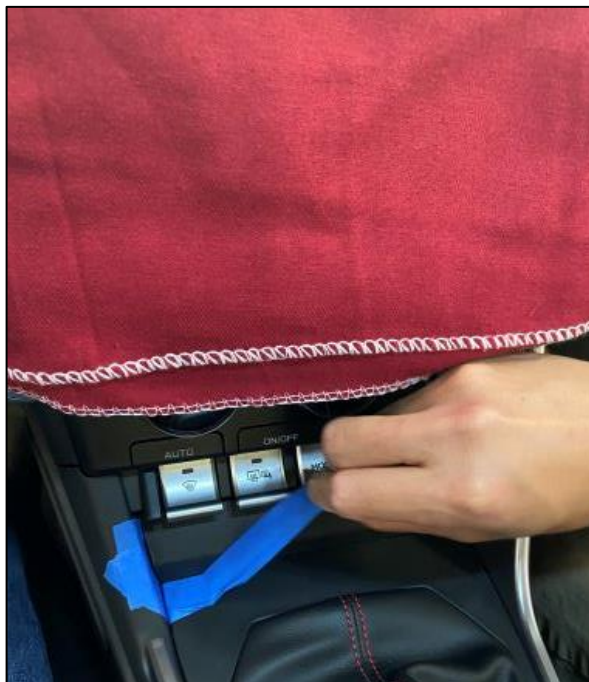

2022MY BRZ Short Throw Shifter Port Installation Instructions

BRZ Battery Reconnection

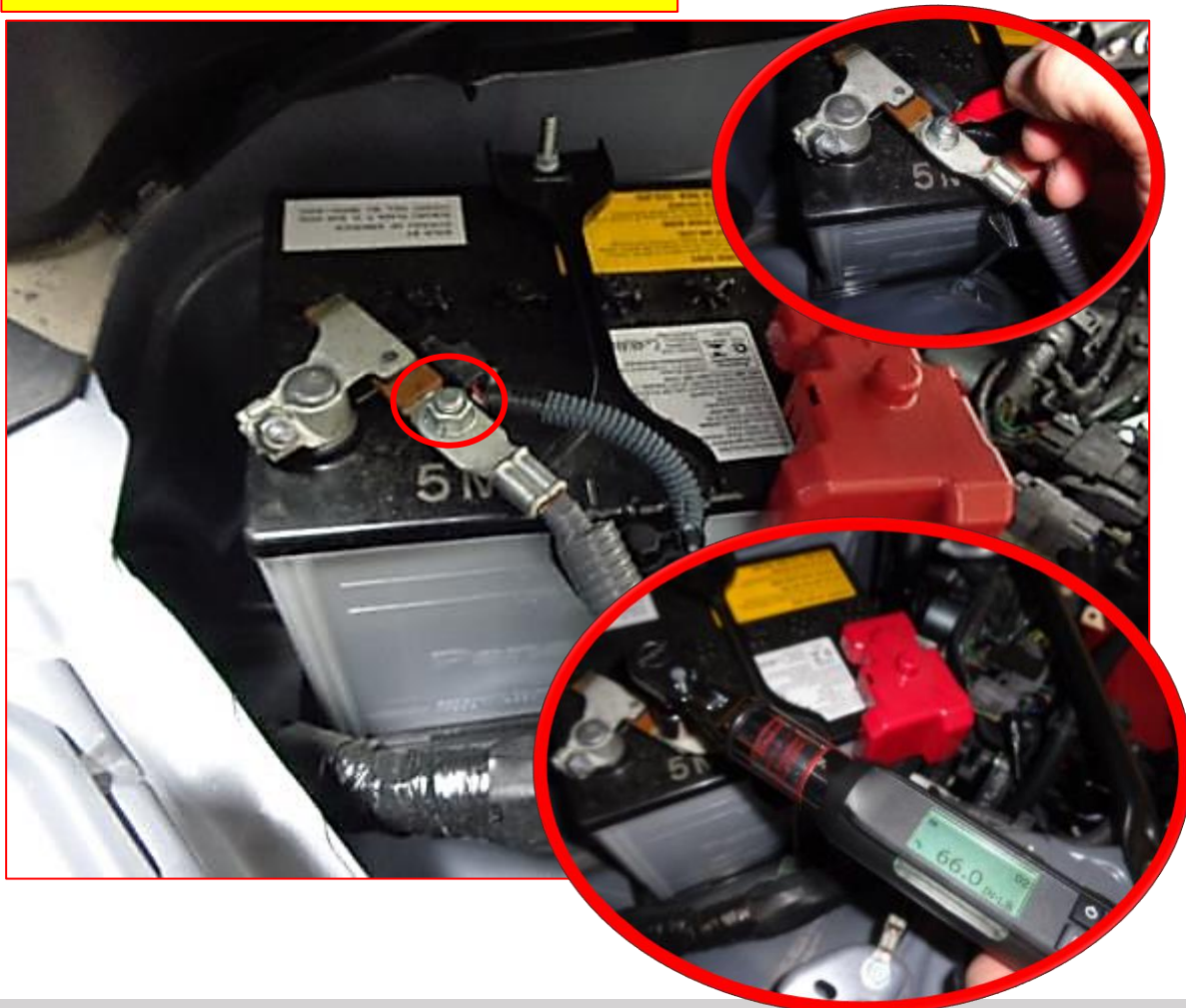

Using a ¼" drive ratchet and 12mm socket reinstall the negative battery cable to the negative battery stud. Torque the 12mm stud nut to 5.5 Ft. Lbs. or (66 Inch Lbs.) Mark with a metal paint marker.



Carefully reinstall the negative battery cable to the battery stud only.

2022MY BRZ Short Throw Shifter Port Installation Instructions

Work Validation: Check Your Work:

- Ensure the console and surrounding parts including the parking brake cover are properly seated in place.
- Observed the interior for scratches, scuffs, grease and other soiled areas, clean as required.
- Ensure the parking brake disengages and engages properly.
- Ensure the shifter is firmly seated in the shifter mount. No loose shifter feel observations.
- Ensure the shift knob is properly oriented so the shift pattern is facing forward and properly tightened in position.
- Press in on the clutch pedal and move the shifter through all gears including reverse gear position. Confirm all gear selections are observed.
- Confirm all torque checks, confirmations and identifications are in place. See note below in “red”.
- Confirm the ignition key / key FOB will start the engine when the clutch pedal pressed to disengage the clutch. Keep the other foot on the brake pedal.
- With ignition “ON” Engine “ON”;
- Ensure the seat heater switches illuminate. (If equipped).
- Confirm the stability switch operation by the illuminated icon on the instrument panel display.
- Observe and confirm the reverse light illuminate when the shifter is in the reverse position.
- Turn the ignition to the “OFF” position.
- **Note: Torque confirmation buddy check verification must be done during short throw shifter assembly. This is the processor’s responsibility.**

2022MY BRZ (MS2) Short Throw Shifter Port Installation Instructions

Work Validation: Check Your Work:



Pull up on the slide ring to select reverse gear.

Work Validation: Ensure vehicle transmission engages all (6) forward gears and reverse gear via lock-out. Reverse gear cannot be engaged without lock-out slide.



Work Validation: Ensure vehicle reverse lights illuminate when the transmission is placed in reverse gear via lock-out.



Work Validation: Ensure proper seat heater operation in both modes if equipped.



Work Validation: Ensure proper stability switch operation.

2022MY BRZ Short Throw Shifter Port Installation Instructions

Document History

<u>Revision</u>	<u>Date</u>	<u>Slide#</u>	<u>Description</u>	<u>Author</u>
A	8/25/2021	N/A	Original Release	RM
B	10/21/2021	20	Added Caution Statement for proper snap ring installation procedure	RM