

2022MY WRX Short Throw Shifter Port Installation Instructions



Ensure the VIN matches the work order, the vehicle due date is in the lock period, and verify there are no "Holds" on the vehicle for any reason. Verify the vehicle calls for the accessory installation.



PN: C1010VA001



CAUTION: ACCESSORY INSTALLATIONS PERFORMED BY UNTRAINED PERSONS COULD RESULT IN SERIOUS INJURY TO THOSE PERSONS OR TO OTHERS. Subaru Work Instructions are intended for use by professional accessory installers ONLY. They are written to provide step by step accessory installation instruction for a fast-paced production environment. Properly trained accessory installers have the equipment, tools, safety instructions and know-how to do the job correctly and safely. Included in this information are the use of "special" accessory installation fixtures and templates that are not available to the Retailers or general public. Please refer to the Retailer Installation Instructions found in Subaru Tech Info System (STIS).

SUBARU OF AMERICA, INC. IS "ISO 14001 COMPLIANT"
The international standard for excellence in Environmental Management Systems. Please recycle or dispose of automotive products in a manner that is friendly to our environment and in accordance with all local, state and federal laws and regulations.

2022MY WRX Short Throw Shifter Port Installation Instructions

Inspect the Short Throw Shifter Assembly for damage, defects, or missing items

Kit Contents

- (1) Short Throw Shifter Assembly.
- (1) Cable Housing
- (1) Cable Housing Plate

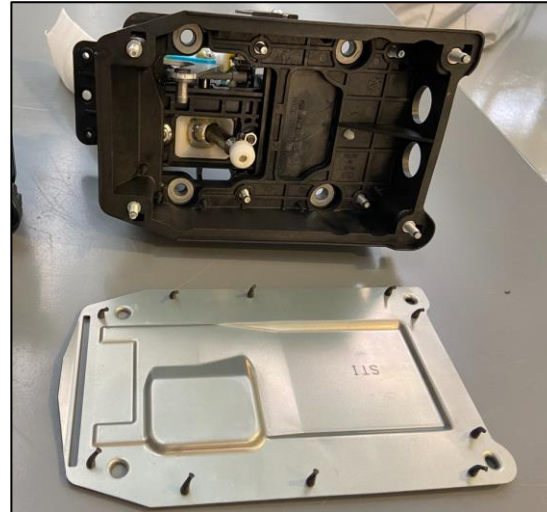
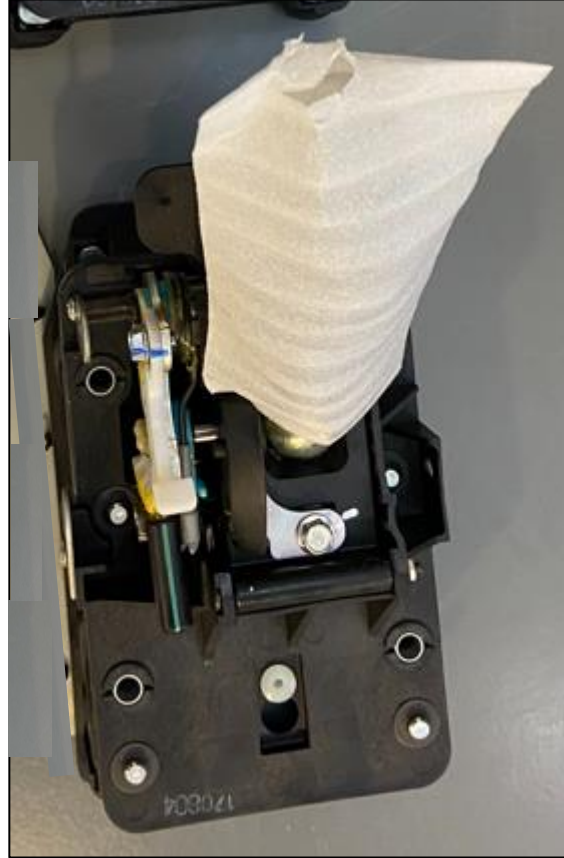

Stop: Damage may occur to the vehicle/part. Do not proceed until process has been complied with.



Work Hazard Analysis (WHA): Operator safety-Use caution to avoid risk of injury.



Caution: A process that must be carefully observed in order to reduce the risk of damage to the accessory/vehicle and to ensure a quality installation.

II

Revision Mark/Highlight: This mark highlights a change in installation with respect to the previous issue.



Work Instruction Training (WIT): Key point that designates an important step to ensure the quality of the installation.



Recycling

Recycle: Item to be recycled.



Safety Torque - This mark indicates that a torque is related to safety



2022MY WRX Short Throw Shifter Port Installation Instructions

OE and Accessory Short Throw Shifter Identification

- We highly recommend marking the accessory short throw shifter with the metal marker to prevent mixing up with the OE Shifter.



Mark Here with a metal marker.

Difference between OE Shifter assembly compared to the Accessory Short Throw Shifter

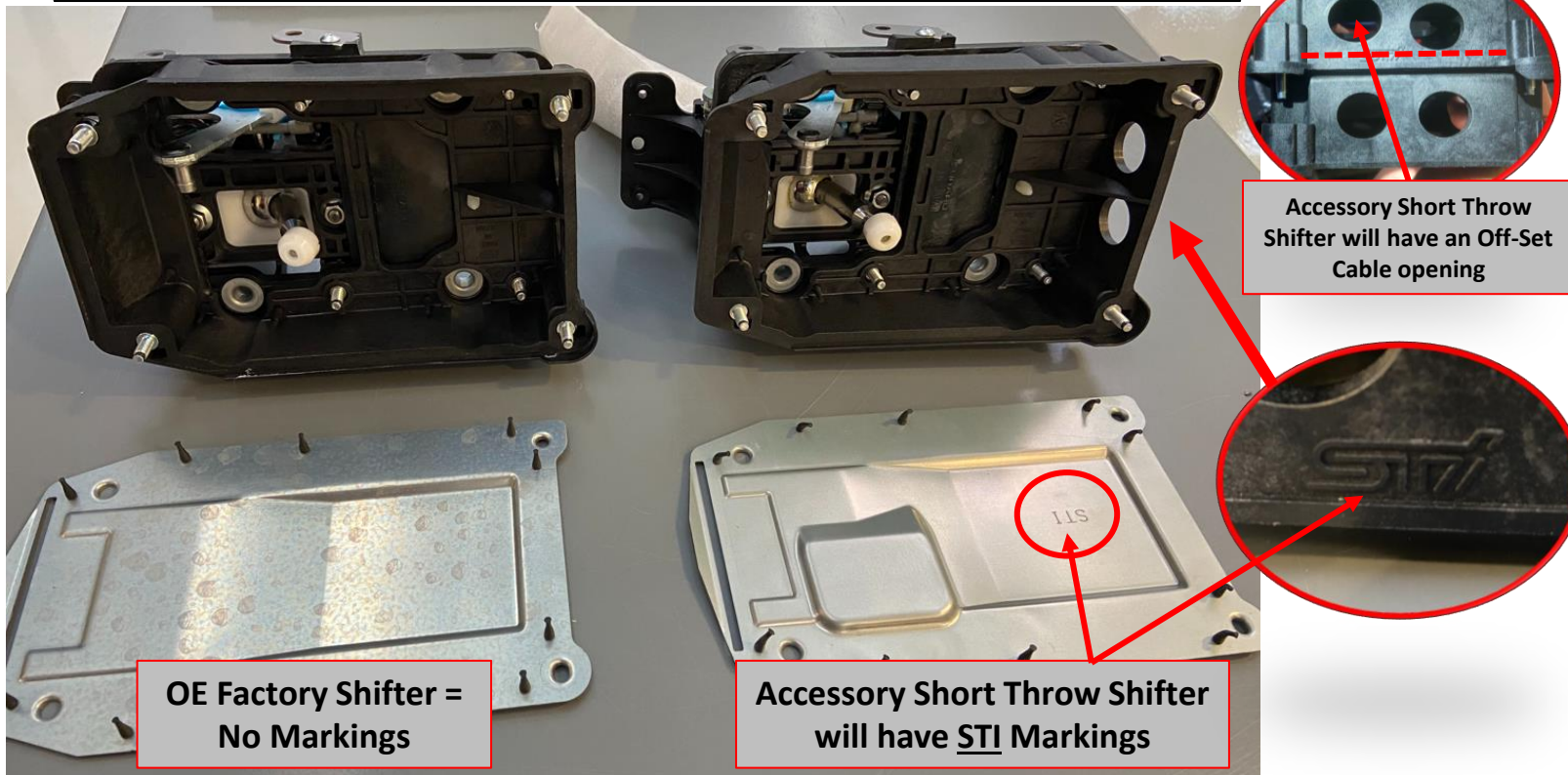

OE Factory Shifter =
No Markings

Accessory Short Throw Shifter
will have STI Markings

Accessory Short Throw
Shifter will have an Off-Set
Cable opening

WIT We highly recommend marking the Accessory Short Throw Shifter with the metal marker to prevent mixing up with the OE Shifter.

2022MY WRX Short Throw Shifter Port Installation Instructions

Required Tools and Equipment

Required tools:

- #2 Phillips Screwdriver
- Flat Blade Screwdriver (Not shown)
- Nylon Trim Tool
- 1/4" dr. Torque Wrench
- 1/4" dr. Ratchet
- 1/4" dr. 10mm, and 12mm sockets. (Magnetic recommended)
- 1/4" dr. Short and Long Extensions.
- 3/8' Ratchet
- 3/8" dr. 12mm and 14mm sockets.
- 3/8" dr. Torque Wrench
- 3/8" dr. extension
- Vehicle protection
- Torque Marker
- Flashlight (Not Shown)
- PPE (Recommended)
- USB Tester (Multiple on-line sources)



2022MY WRX Short Throw Shifter Port Installation Instructions

Preparation

1. Position the vehicle according to the lift manufacturer specifications to be safely lifted for access and work under the vehicle.
2. Position vehicle on the drive on car ramps to safely access and work under the vehicle.

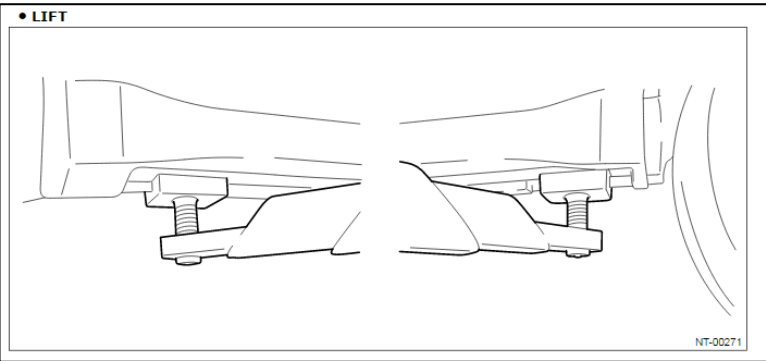

Do not raise the vehicle on the lift at this time. Vehicle safely driven up on ramps is okay if there is clear and safe access to the undercarriage and vehicle interior to follow this procedure.

2022MY WRX Short Throw Shifter Port Installation Instructions

Preparation

1. Install interior vehicle protection.
 2. Engage the parking brake.
- *Do not apply excessive force that can damage the parking brake and components.*



Do not apply excessive force. Damage to the parking brake and/or components may result.



2022MY WRX Short Throw Shifter Port Installation Instructions

Preparation

1. Adjust the LF seat to the full forward position for access to the rear console box area and remove the bolt cover with a plastic trim tool.
 2. Using a $\frac{1}{4}$ " drive ratchet with 6" extension and 10mm socket, remove the 10mm bolt. Save bolt and bolt cover for reinstallation.
 3. Return the LF seat to the full rear position
- (Repeat sequence on the RH side of the vehicle.)

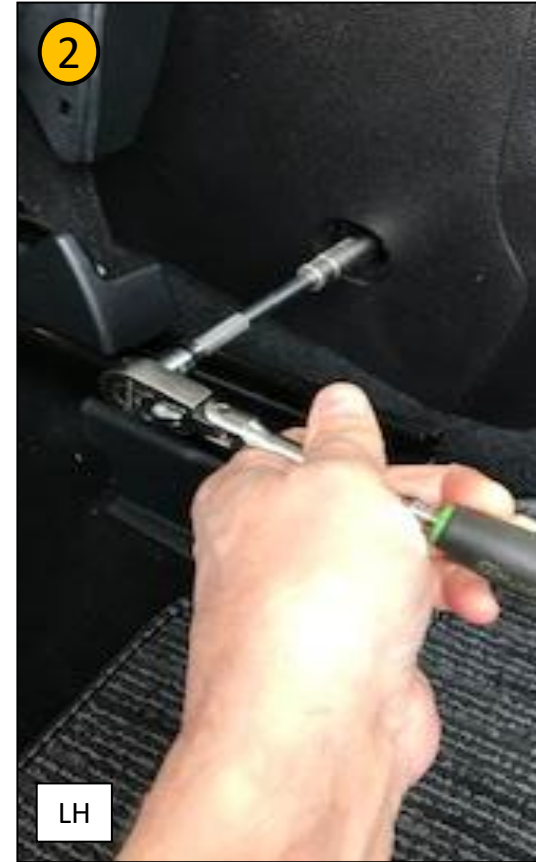

2022MY WRX Short Throw Shifter Port Installation Instructions



While disconnecting the negative battery cable from the stud, hold the battery sensor in place with one hand while loosening the 10mm hex nut that secures the cable to the sensor. This will help support the sensor to prevent damage and also prevent the assembly from rotating on the battery post causing a poor connection. ⚠

Open the hood and use the prop rod to hold the hood in the open position. While holding the battery sensor in place with one hand, use a ¼" drive ratchet and 10mm socket to remove the negative battery cable from the negative battery stud. Do not remove negative cable from the battery post. Position / protect the negative cable so it cannot accidentally touch body ground or the negative the battery terminal. Allow (60) seconds before the next installation step to ensure the airbag power supply is discharged.

⚠ Carefully remove the negative battery cable from the battery stud only. Do not allow the negative cable accidentally ground during the accessory installation.

2022MY WRX Short Throw Shifter Port Installation Instructions

OE Shifter Removal

1. Remove the parking brake boot / trim by pulling straight up to disengage the (5) retaining clips, then carefully work the boot over and off the parking brake handle.
 2. Remove the shift knob by unscrewing it counterclockwise.
- Place the parking brake boot / trim panel and Shift Knob aside on a clean protected surface for reinstallation.

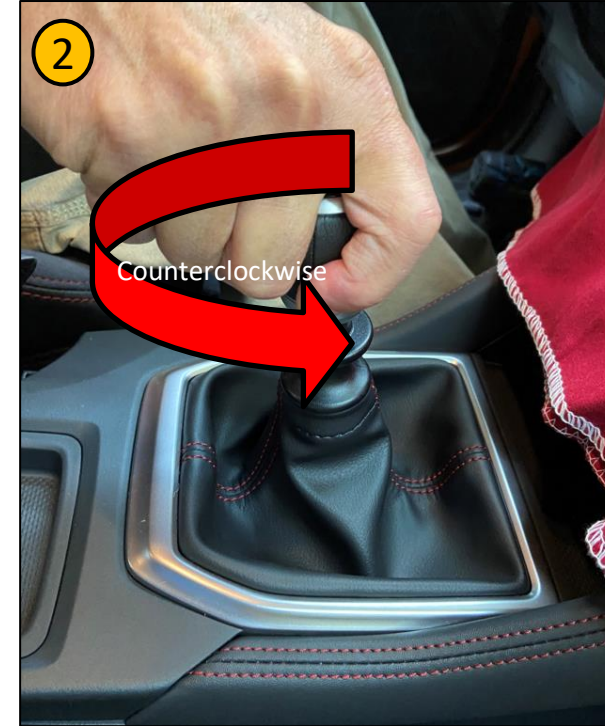

2022MY WRX Short Throw Shifter Port Installation Instructions

OE Shifter Removal

1. Using your hands, carefully lift and disengage the (8) clips securing the shifter boot bezel trim / front pocket panel.
2. Once the trim panels clips are free, pull the trim panel assembly rearward to disengage the (3) front panel tabs.
3. To complete removal of the boot / trim panel assembly, carefully work the boot over and off the shifter reverse lock-out knob.
➤ Place the boot bezel / pocket trim aside for reinstallation.

⚠ Take care not to damage or scratch any panels during removal.

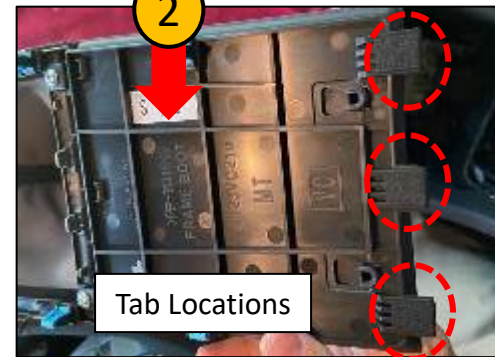
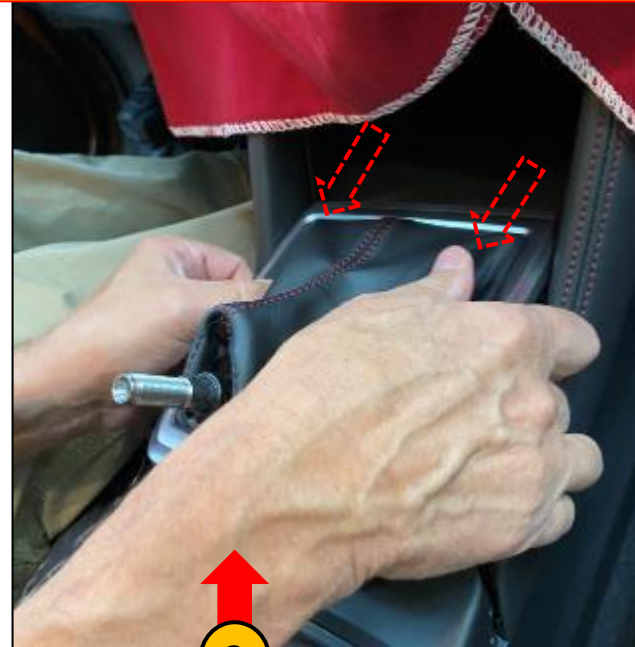
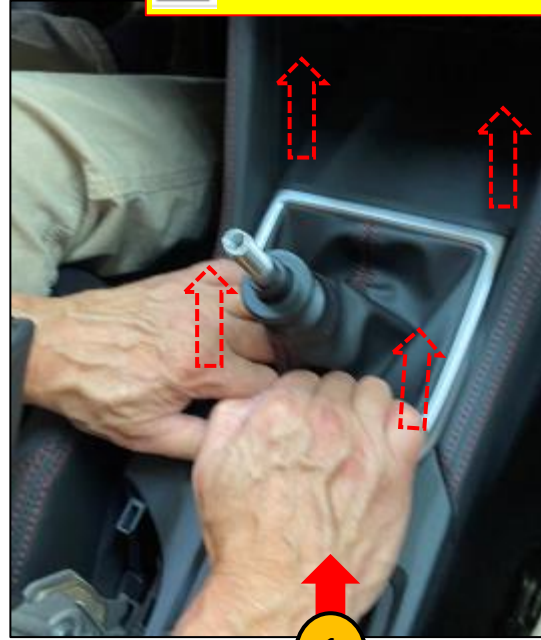

2022MY WRX Short Throw Shifter Port Installation Instructions

OE Shifter Removal

1. Open the center console lid.
2. Carefully lift and disengage the center cup holder trim panel clips.
3. While holding the trim panel with one hand, disconnect the white electrical connector shown. (Remove the panel and place aside for reinstallation)
4. Remove the (2) #2 Phillips screws shown from the rear of the side panels and (1) #2 screw from right front of the console box.

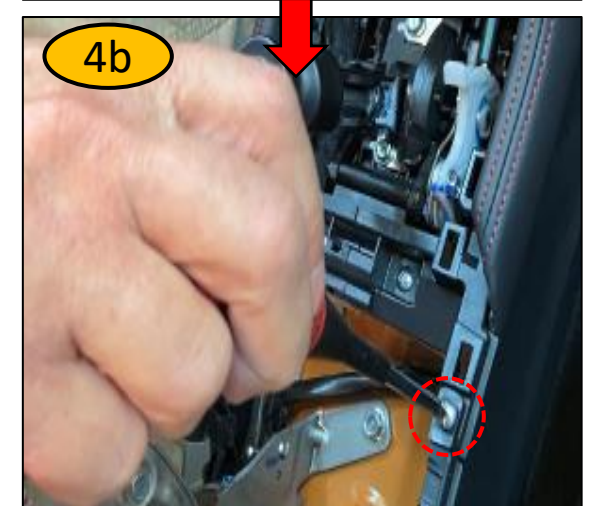
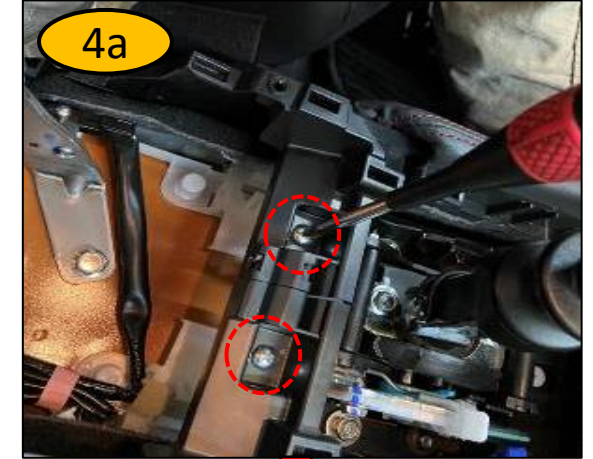

Take care not to damage or scratch any panels during removal.

2022MY WRX Short Throw Shifter Port Installation Instructions

OE Shifter Removal

1. Carefully unseat the front corners of the console box then slide the rear console box rearward to allow for side trim panel removal.
2. Release and separate the rear side trim panels. (Use plastic trim tool to release if needed)
3. Remove the LH and RH side trim panel by pulling rearward to release the front of the panel. (Set the panels aside for reinstallation)

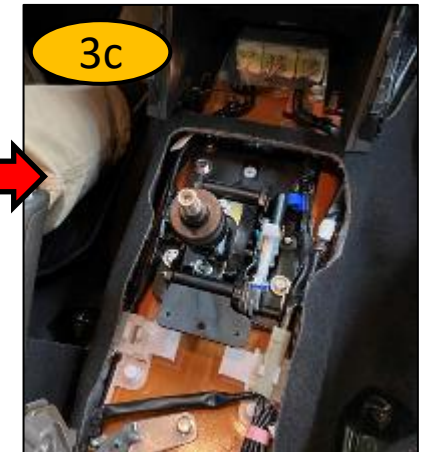
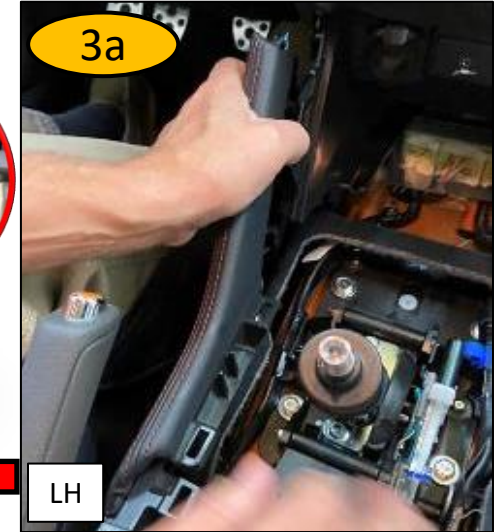
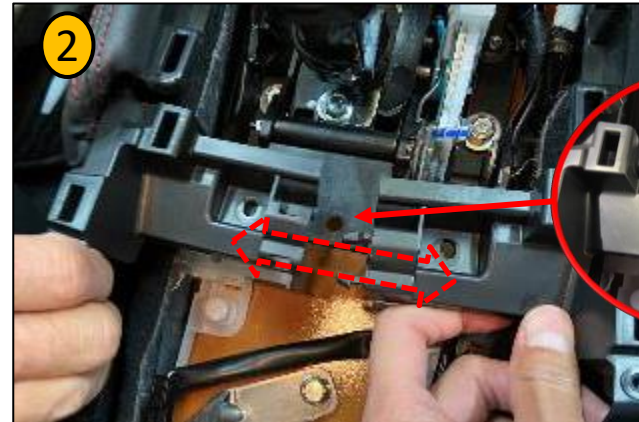

Take care not to damage or scratch any panels during removal.



2022MY WRX Short Throw Shifter Port Installation Instructions

OE Shifter Removal

1. Release the wire harness holder clips from the left and right side of the OE shifter assembly.
2. Using a 3/8" ratchet, extension, and 12mm socket, remove the (4) bolts shown from the OE shifter lever. (Save the bolts for reinstallation)

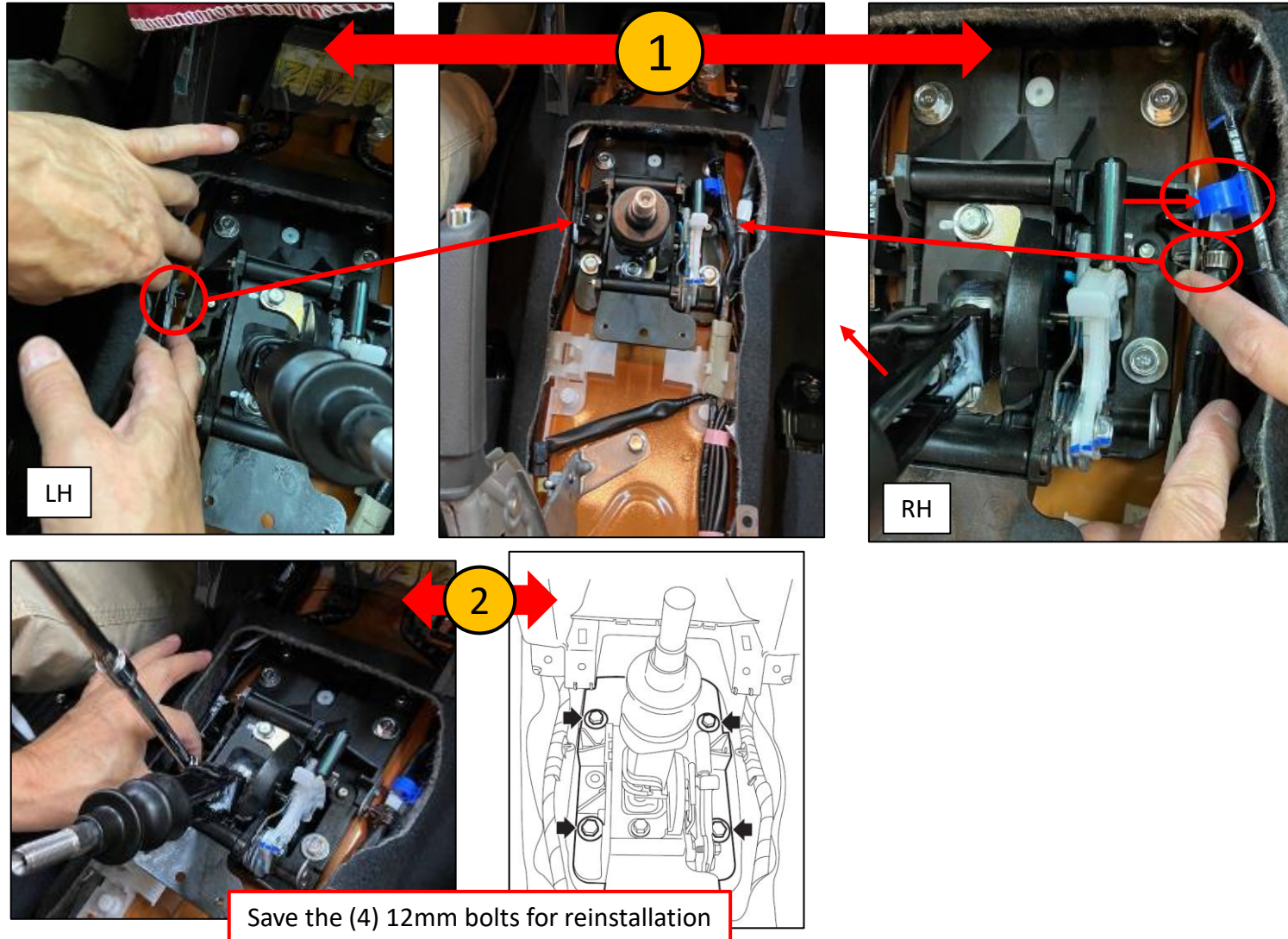

2022MY WRX Short Throw Shifter Port Installation Instructions

OE Shifter Removal

1. Safely **raise** the vehicle by lift to access the shifter linkage under the vehicle.
2. If already on car ramps move to the next step.

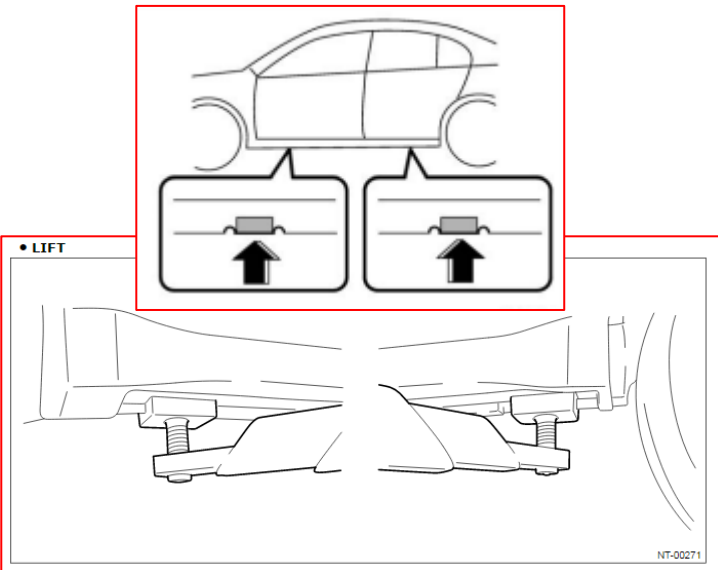

Always follow the lift manufacturers and the Subaru WRX Service Manual when lifting the vehicle to safely work underneath.

2022MY WRX Short Throw Shifter Port Installation Instructions

OE Shifter Removal

1. Using a 3/8" ratchet and 14mm socket, remove the front exhaust bracket bolt.
2. Remove the (6) 12mm heat shield bolts shown.
3. Carefully remove the heatshield while shifting the exhaust as needed to prevent damage. (Set heatshield aside for reinstallation)

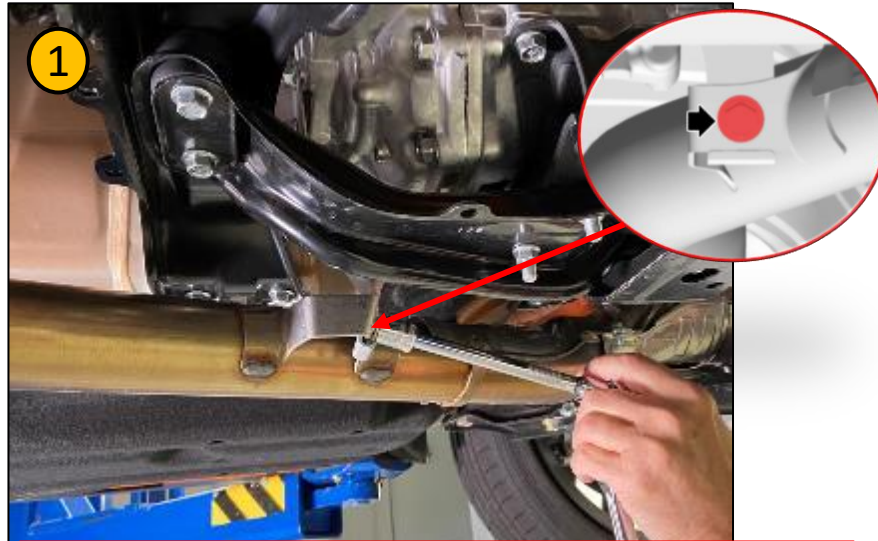

Save the (1) 14mm bolt and (6) 12mm bolts for reinstallation

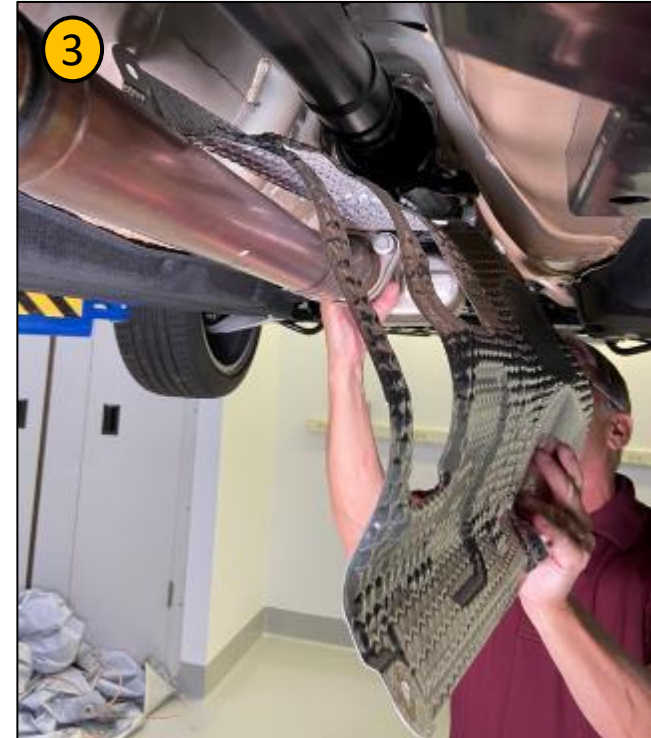
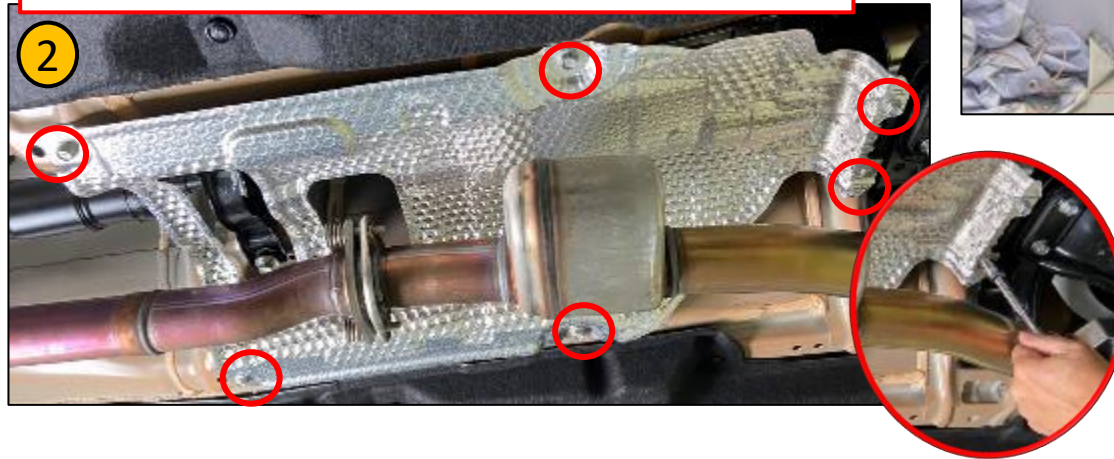

2022MY WRX Short Throw Shifter Port Installation Instructions

OE Shifter Removal

1. Remove the cable housing plate by using a ¼" ratchet, 10mm socket, and long extension to remove the (4) nuts shown. (Properly discard / dispose of the plate) 
2. Remove the (2) spring clamps holding the shift cables to the cable housing.
3. Remove the MT gear select cable from the gear shift lever assembly by inserting a nylon trim tool to gently pry apart.

Save the (4) 10mm nuts and (2) spring clamps for reinstallation

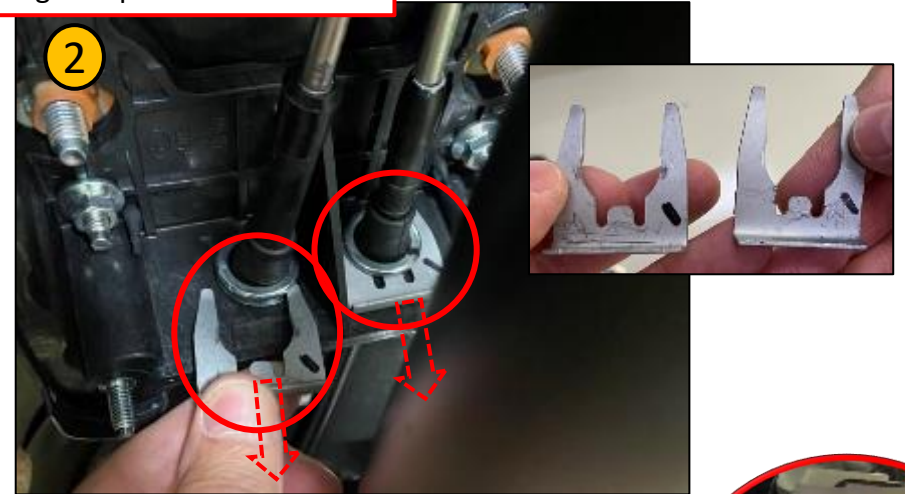
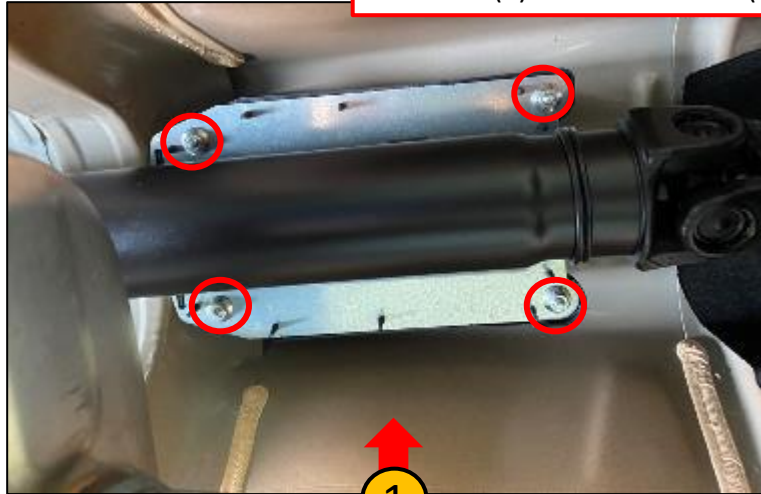

2022MY WRX Short Throw Shifter Port Installation Instructions

OE Shifter Removal

1. Remove the MT gear shift cable from the gear shift lever by expanding the spring clip and pulling down to disengage. (**Do not remove the Spring Clip**)
2. Remove the (4) 10mm nuts holding the linkage housing in place.
3. Carefully remove the (2) cables from the housing and remove the cable housing assembly. (Properly discard / dispose the housing) 

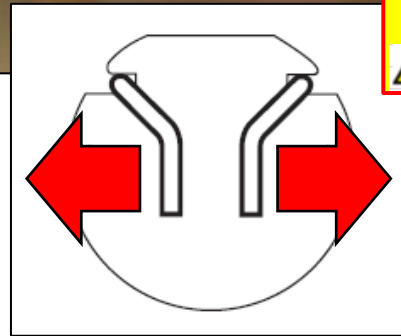
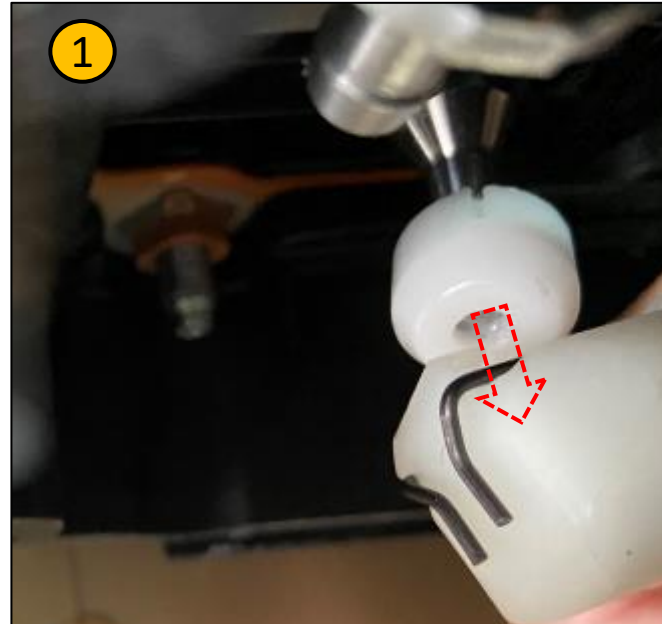

Do not remove
⚠ spring clip. ⚠

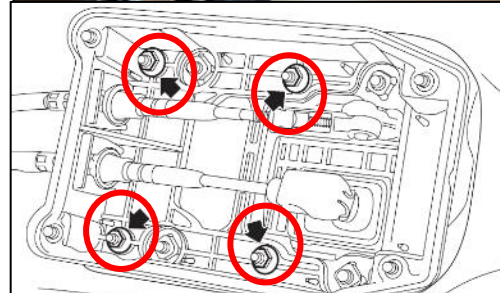

Save the (4) 10mm nuts for reinstallation



2022MY WRX Short Throw Shifter Port Installation Instructions

Short Throw Shifter Installation

1. Take the accessory Short Throw Shifter cable housing and feed the gear shift and gear select cables through the appropriate cable openings.
2. Rest the cable housing assembly in place above the propeller shaft and under the OE shifter assembly.

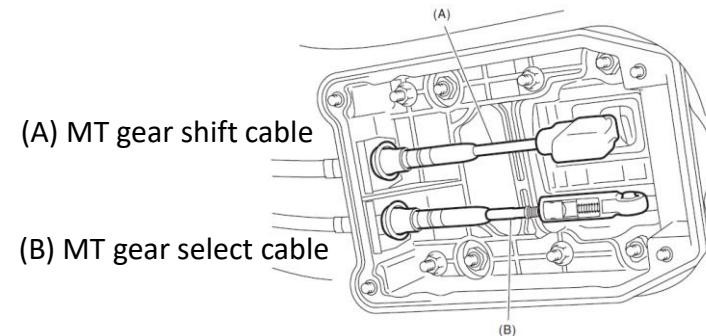
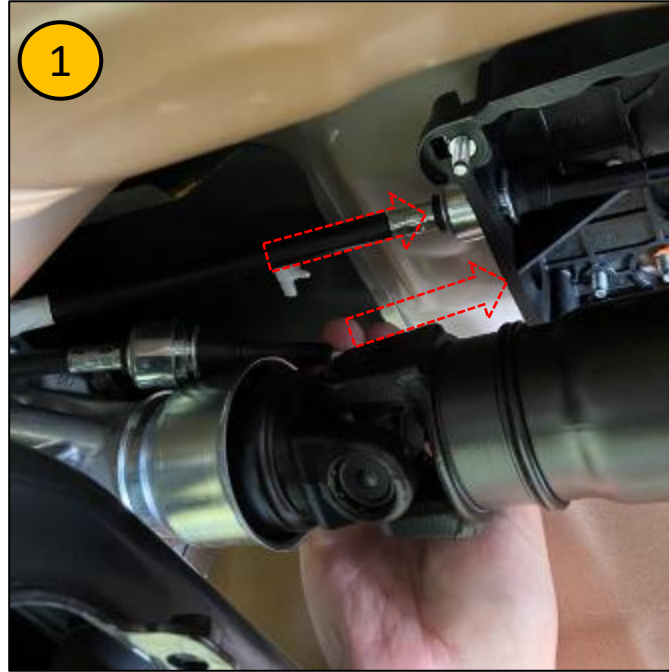

2022MY WRX Short Throw Shifter Port Installation Instructions

OE Shifter Removal

1. Safely **lower** the vehicle to access the vehicle interior for gear shift lever removal.
2. If already on car ramps move to the next step.

• LIFT

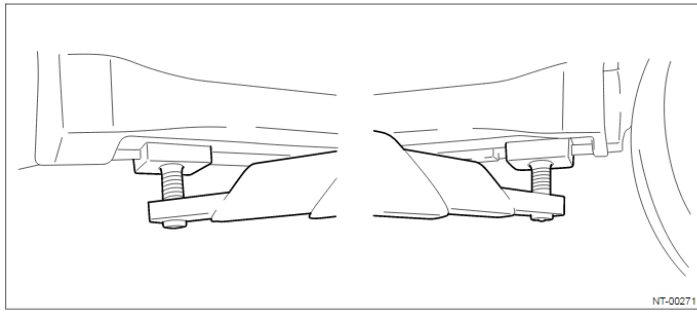



Always follow the lift manufacturers and the Subaru WRX Service Manual when lifting the vehicle to safely work underneath.

2022MY WRX Short Throw Shifter Port Installation Instructions

Short Throw Shifter Installation

1. Carefully lift and remove the OE shifter lever. (Properly discard / dispose the OE shifter) 
2. Carefully feed the Short Throw Shifter through the floor opening and into place.



Take care not to damage or scratch any part of the interior during removal or installation.  

2022MY WRX Short Throw Shifter Port Installation Instructions

Short Throw Shifter Installation

1. Align bolt holes and Hand start the (4) 12mm bolts previously removed.
2. Torque the (4) 12mm bolts to 13.3 ft.-lbs. (160 Inch-lbs., 18 Nm)
➤ Torque mark the bolts.
3. Re-attach wire harness holder clips to the left and right sides of the Short Throw shifter assembly.

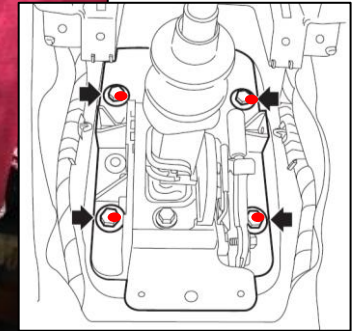
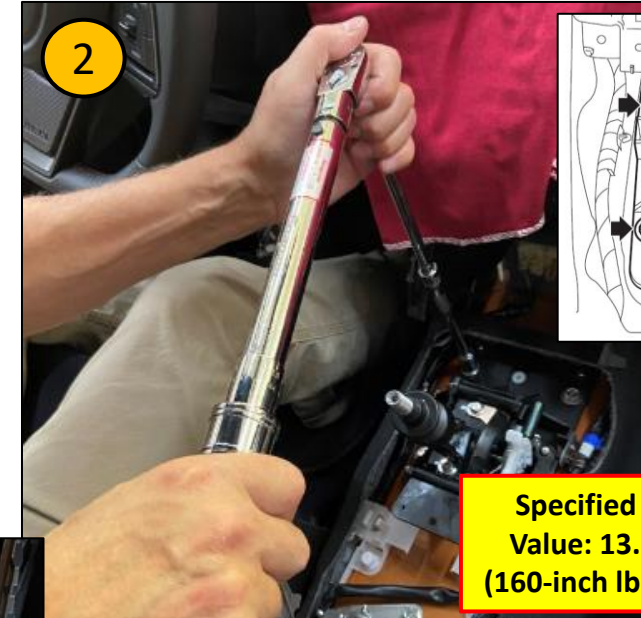

Specified Torque Value: 13.3-ft lbs. (160-inch lbs., 18Nm)

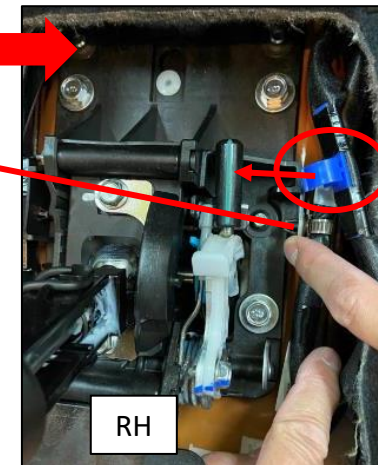
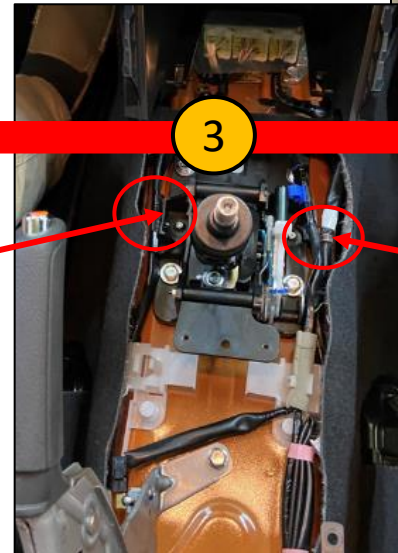

2022MY WRX Short Throw Shifter Port Installation Instructions

OE Shifter Removal

1. Safely **raise** the vehicle by lift to access the shifter linkage under the vehicle.
2. If already on car ramps move to the next step.

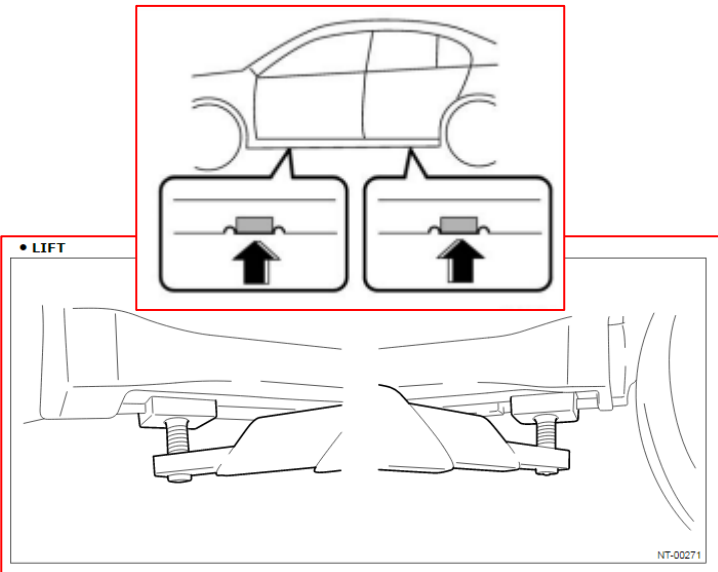

Always follow the lift manufacturers and the Subaru WRX Service Manual when lifting the vehicle to safely work underneath.

2022MY WRX Short Throw Shifter Port Installation Instructions

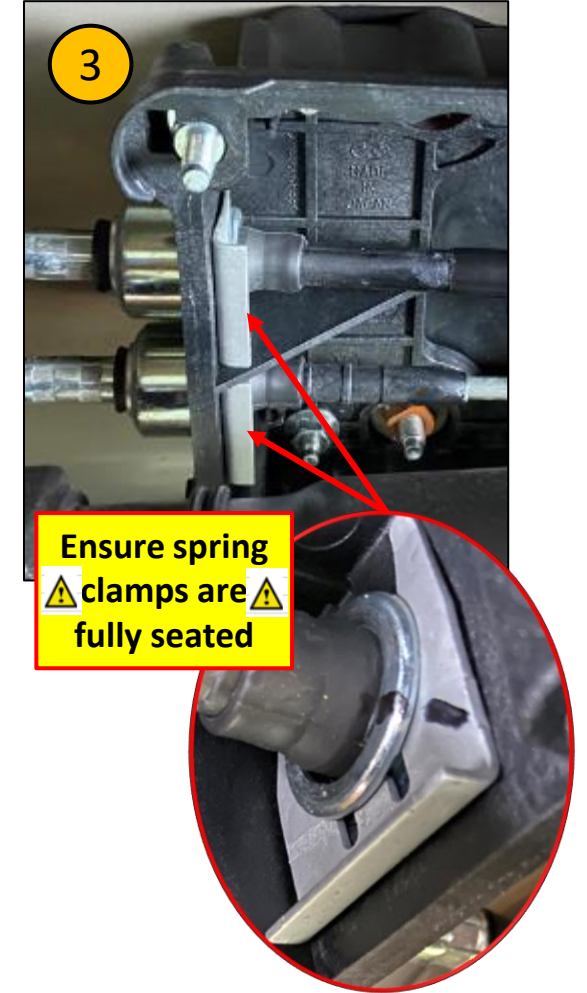
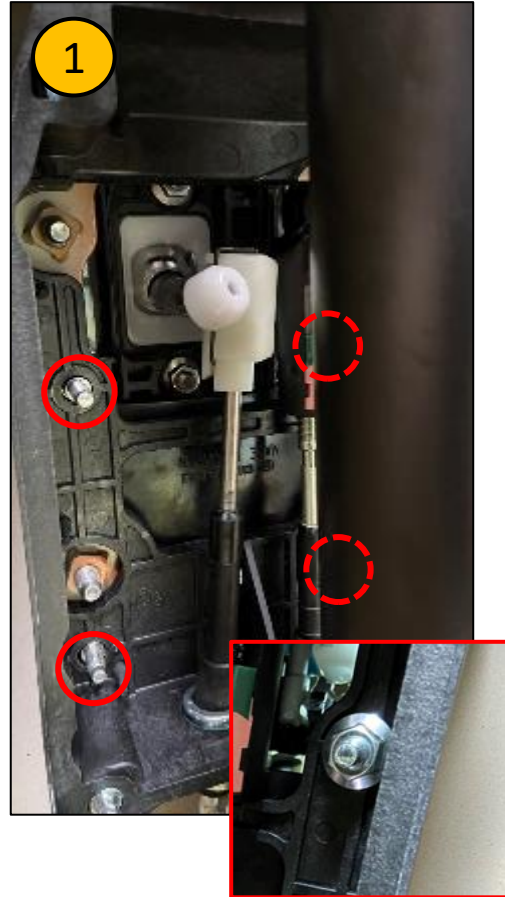

Short Throw Shifter Installation

1. Position the cable housing assembly onto the mounting studs and hand start the (4) 10mm nuts previously removed.
2. Torque the (4) 10mm nuts to 66 inch-lbs. (5.5 ft-lbs., 7.5 Nm)
 - Torque mark nuts.
3. Fully seat the gear shift and gear select cables against the cable housing and install (2) spring clamps previously removed. **(Ensure spring clamps are properly installed and fully seated)**



2022MY WRX Short Throw Shifter Port Installation Instructions

Short Throw Shifter Installation

1. Re-install the gear select cable by pushing onto the shift lever assembly. (Ensure the cable is fully seated on the lever and locked in position)

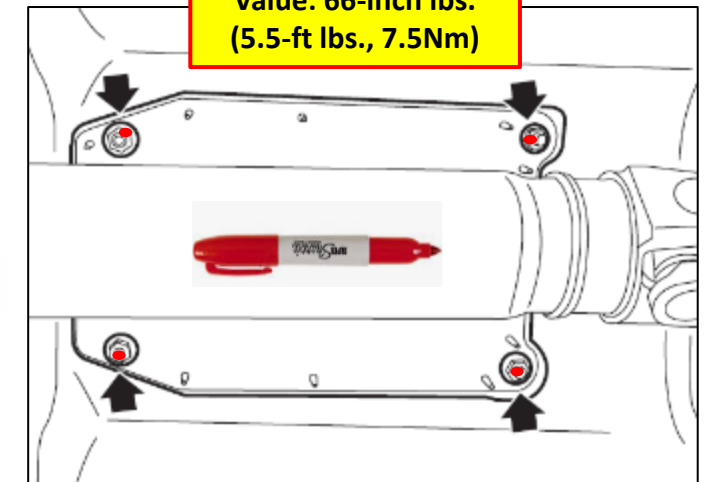
2. Re-install the gear shift cable by pushing up onto the shift lever assembly. (Ensure the cable is fully seated on the lever and locked in position with spring clip in place)

3. Reinstall the cable assembly plate with (4) 10mm nuts and torque to 66 inch-lbs.
➤ Torque mark nuts.

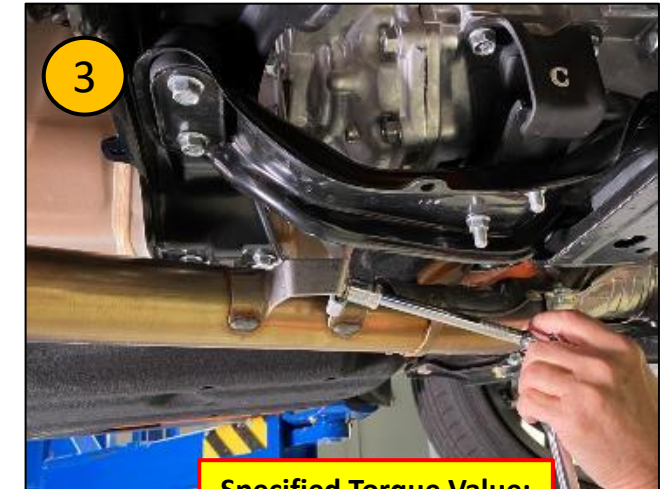
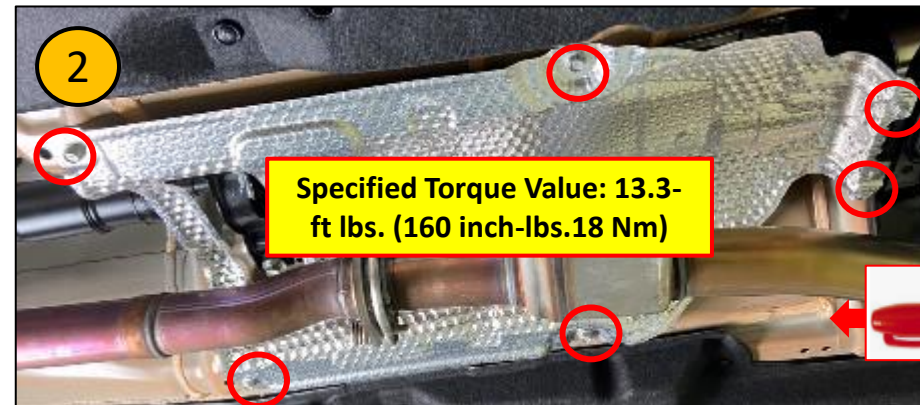
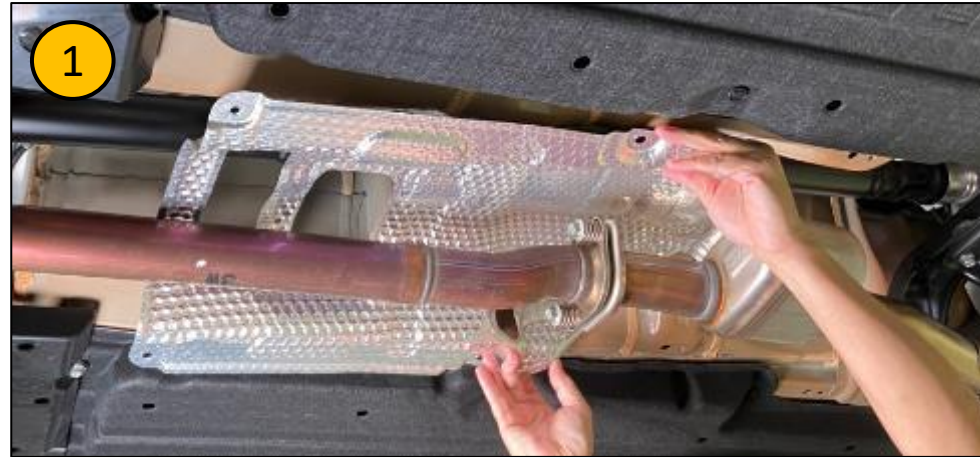

2022MY WRX Short Throw Shifter Port Installation Instructions

Short Throw Shifter Installation

1. Re-install the Heat Shield and hand start the (6) 12mm bolts previously removed.
2. Torque the (6) 12mm bolts to 13.3 ft-lbs. (160 inch-lbs., 18 Nm)
 - Torque mark bolts.
3. Reinstall the (1) 14mm exhaust hanger bracket bolt previously removed and torque to 25.8 ft-lb (35 Nm)
 - Torque mark bolt.



**Specified Torque Value:
25.8-ft lbs. (35 Nm)**

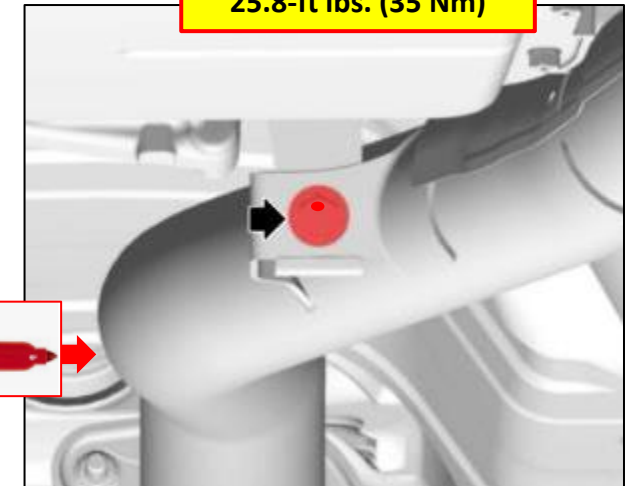

2022MY WRX Short Throw Shifter Port Installation Instructions

Short Throw Shifter Installation

1. Safely **lower** the vehicle to access inside the vehicle for interior reassembly.
2. If already on car ramps move to the next step.

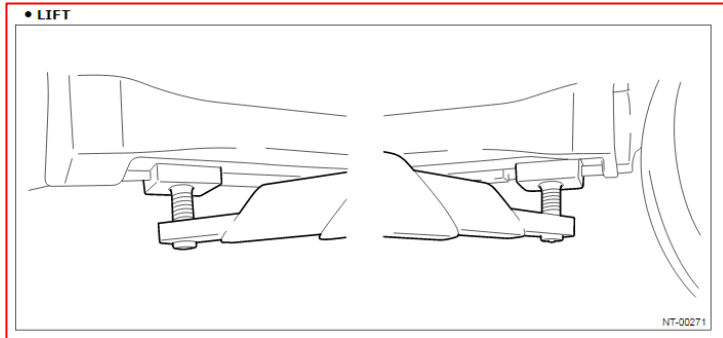

Always follow the lift manufacturers and the Subaru WRX Service Manual when lifting the vehicle to safely work underneath.

2022MY WRX Short Throw Shifter Port Installation Instructions

Short Throw Shifter Installation

1. Reinstall the LH and RH side trim panel by aligning clips with dash panel openings and pushing forward to fully seat the front of the panel.

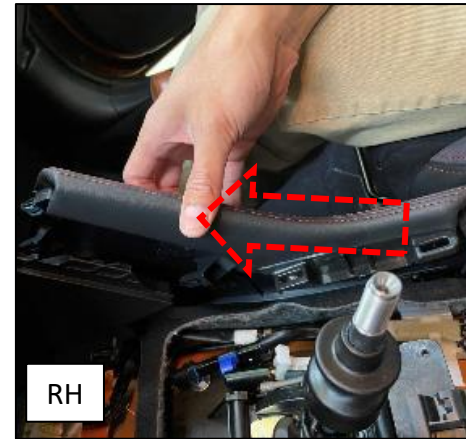
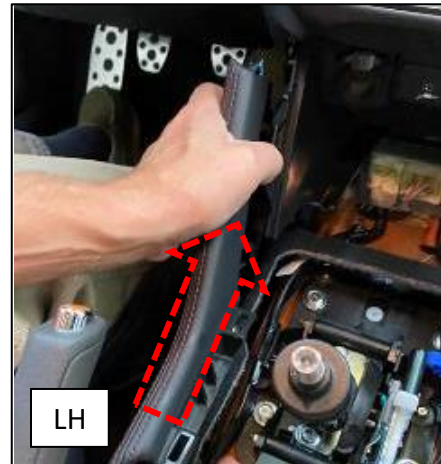
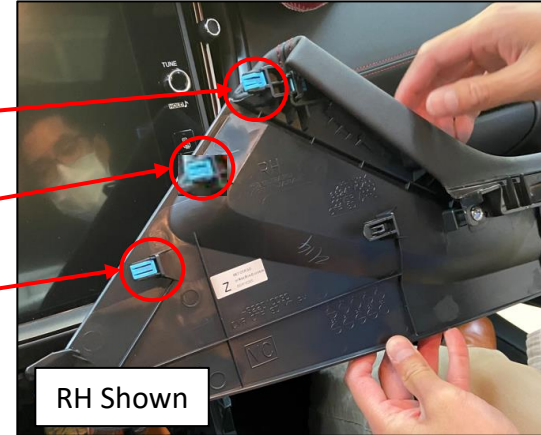

Take care not to damage or scratch any panels during reinstallation.



2022MY WRX Short Throw Shifter Port Installation Instructions

Short Throw Shifter Installation

1. Align the rear side trim panels and snap together. (Ensure the panels are fully seated together)
2. Carefully slide the rear console box forward to align the front screw hole and push down firmly to seat console box clips.
3. Reinstall the (3) #2 screws previously removed. (**Do Not Overtighten**)
4. Open the center console lid.

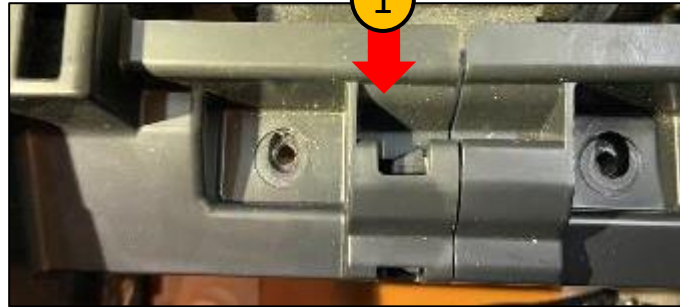
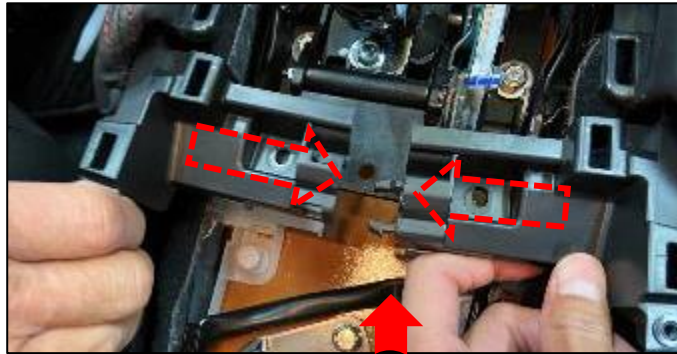

2022MY WRX Short Throw Shifter Port Installation Instructions

Short Throw Shifter Assembly Installation

1. While holding the center cup holder trim panel with one hand, reconnect the white electrical connector shown. (Confirm connection with push – pull method)
2. Carefully align the center cup holder trim panel clips and push in place to fully seat.
3. Close the center console lid.
4. Carefully work the shifter boot over the shifter reverse lock-out knob and reinstall the shifter boot bezel trim by aligning the front tabs and pushing forward. Once tabs are fully engaged, push downward to fully seat the (8) trim clips.

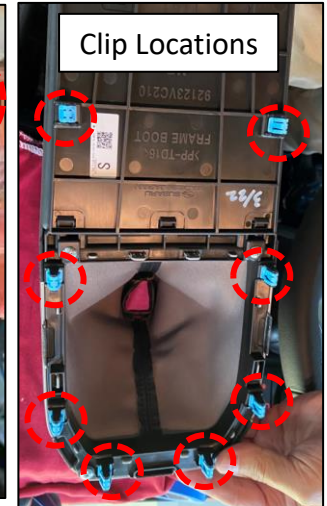
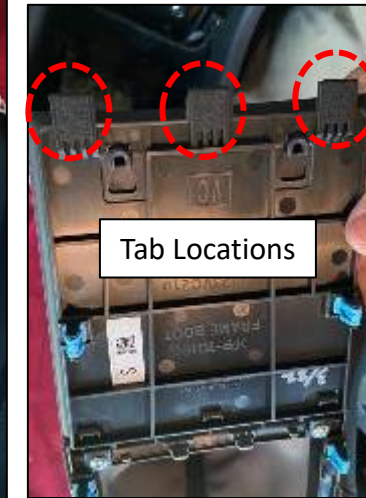
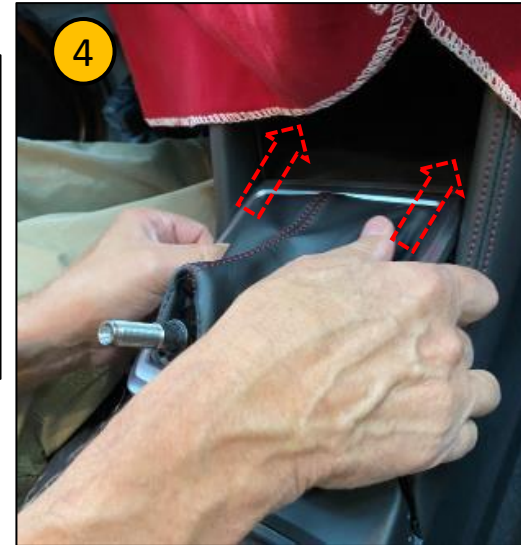

Take care not to damage or scratch any panels during reinstallation.

2022MY WRX Short Throw Shifter Port Installation Instructions

Short Throw Shifter Assembly Installation

1. Re-work the shifter boot to its proper position on the reverse lock-out knob.
2. Reinstall the OE shift knob by screwing it on in a clockwise direction. (Confirm proper orientation)
3. Carefully work hand brake boot over handle, align clips, and reseal hand brake trim. (Confirm trim is fully seated)



Take care not to damage or scratch any panels during reinstallation.



2022MY WRX Short Throw Shifter Port Installation Instructions



While connecting the negative battery cable to the stud, hold the battery sensor in place with one hand while torquing the 10mm hex nut that secures the cable to the sensor. This will help support the sensor to prevent damage and prevent the assembly from rotating on the battery post causing a poor connection. ⚠

Re-connect the negative cable by reinstalling the saved 10mm nut on the stud. Use a ¼" drive torque wrench and a 10mm socket, tighten the cable nut to 66 In. Lbs. while holding the sensor to prevent damage and prevent the assembly from rotating on the battery post.

⚠ Carefully reinstall the negative battery cable to the battery stud only.

Torque mark the battery stud ⚠



2022MY WRX Short Throw Shifter Port Installation Instructions

Short Throw Shifter Assembly Installation

1. Adjust the LF seat to the full forward position for access to the rear console box area.
2. Using a ¼" drive Torque wrench with 6" extension and 10mm socket, install the 10mm bolt previously removed. Torque bolt to 54 Inch lbs. (Torque mark bolt.)
3. Install bolt cover trim and adjust seat to rear position.
 - Repeat steps 1-3 on RH seat / side of the vehicle.

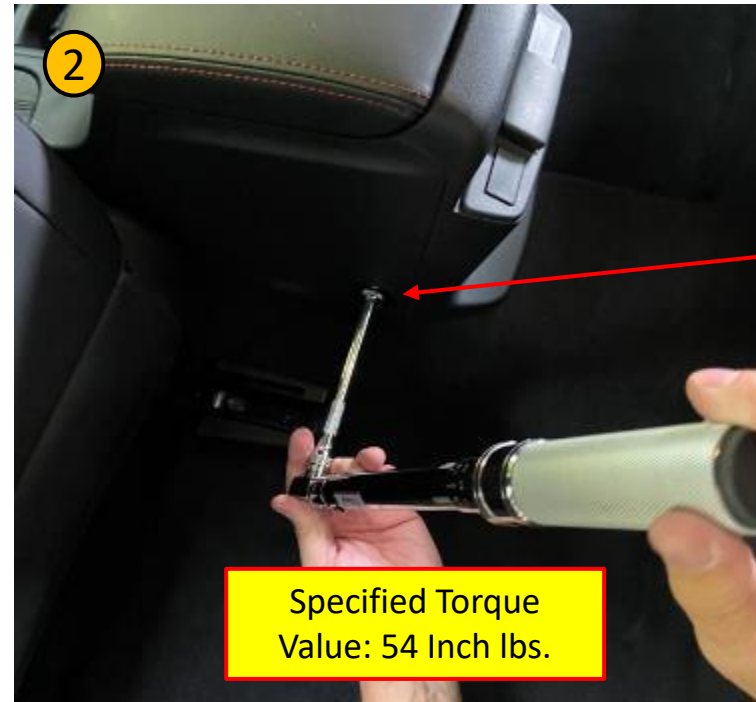

2022MY WRX Short Throw Shifter Port Installation Instructions

Short Throw Shifter Assembly Installation

1. Remove Vehicle protection.
2. Closely inspect the installation area for damage and confirm all trim panels are properly positioned and fully seated.



2022MY WRX Short Throw Shifter Port Installation Instructions

Work Validation: Check Your Work:

- Ensure the console and surrounding parts including the parking brake cover are properly seated in place.
- Observed the interior for scratches, scuffs, grease and other soiled areas, clean as required.
- Ensure the parking brake disengages and engages properly.
- Ensure the shifter is firmly seated in the shifter mount. No loose shifter feel observations.
- Ensure the shift knob is properly oriented so the shift pattern is facing forward and properly tightened in position.
- Press in on the clutch pedal and move the shifter through all gears including reverse gear position. Confirm all gear selections are observed.
- Confirm all torque checks, confirmations and identifications are in place. See note below in “red”.
- Confirm the ignition key / key FOB will start the engine when the clutch pedal pressed to disengage the clutch. Keep the other foot on the brake pedal.
- With ignition “ON” Engine “ON”;
- Observe and confirm the reverse light illuminate when the shifter is in the reverse position.
- Turn the ignition to the “OFF” position.
- Ensure the USB charger(s) outlet operates properly. (if equipped).
- Ensure parking brake indicator light on combo-meter illuminates when parking brake is engaged.
- **Note: Torque confirmation buddy check verification must be done during short throw shifter assembly. This is the processor’s responsibility.**

2022MY WRX Short Throw Shifter Port Installation Instructions

Work Validation: Check Your Work:



Work Validation: Ensure vehicle transmission engages all (6) forward gears and reverse gear via lock-out. Reverse gear cannot be engaged without lock-out slide.



Work Validation: Ensure vehicle reverse lights illuminate when the transmission is placed in reverse gear via lock-out.

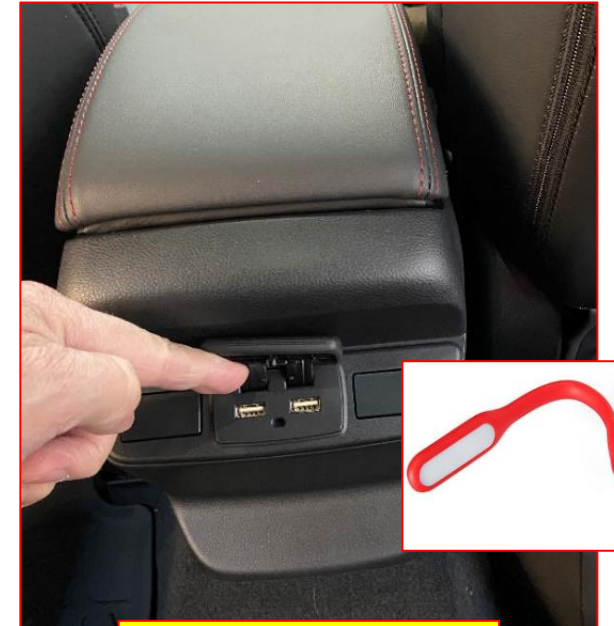

Work Validation: Ensure proper USB charger operation if equipped.

2022MY WRX Short Throw Shifter Port Installation Instructions

Document History

<u>Revision</u>	<u>Date</u>	<u>Slide#</u>	<u>Description</u>	<u>Author</u>
A	2/1/2022	N/A	Original Release	RM
B	2/21/2022	Multiple	Change installation sequence for improved efficiency.	RM
C	3/15/2022	#27 from Rev-B	Remove detent adjustment procedure.	RM
D	3/23/2022	18, 23	Move spring clips installation step from slide 18 to <u>after</u> cable housing has been secured on slide 23.	RM