



SUBARU

PART NUMBER: H461SXC300

INSTALLATION INSTRUCTIONS

DESCRIPTION: Ascent Illuminated Cargo Sill

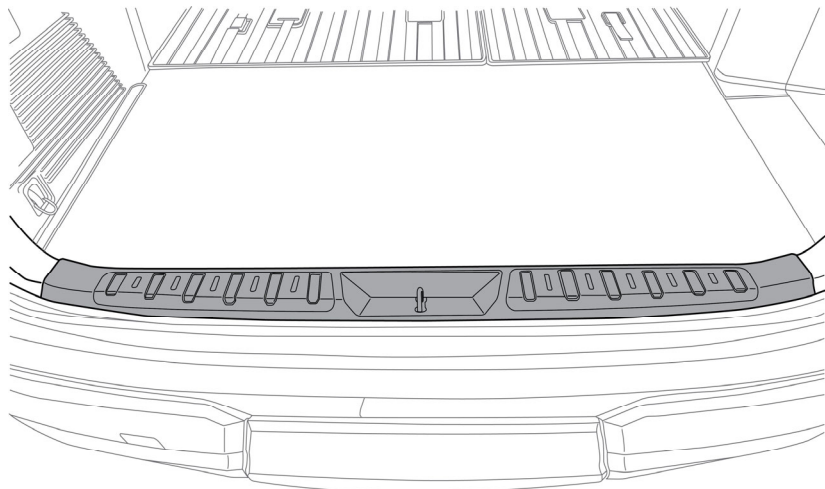

TOOLS REQUIRED:

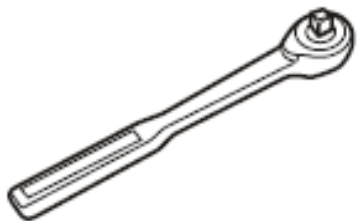

Drive Ratchet



10mm Socket

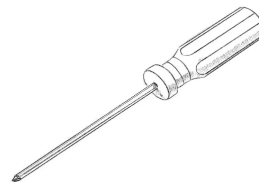

Screwdriver

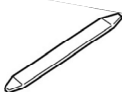

Pry Tool

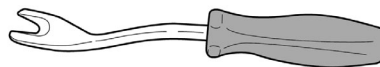

Trim Panel Removal Tool

KIT CONTENTS:

Wire Harness



Cargo Sill

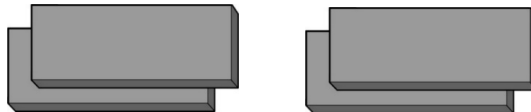

Foam Tape

PART NUMBER:
H461SXC300

ISSUE
00

9/5/2023

SUBARU OF AMERICA

PAGE 1 / 5



STEP 1: Prepare for the Installation.

- (a) Inspect all kit components and check for damage or missing parts.
- (b) Remove the negative battery terminal.

CAUTION: Do not touch the positive terminal with any part of the tool when removing the cable.

STEP 2: Disassemble the Vehicle.

- (a) Remove cargo floor panel from vehicle, as well as any contents in cargo area or other accessories that may be present (tonneau cover).

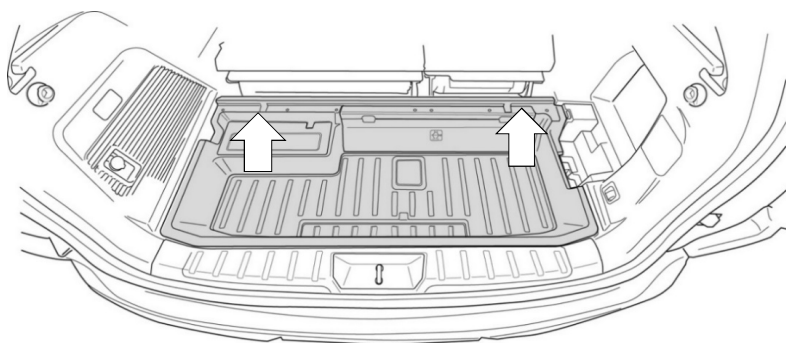
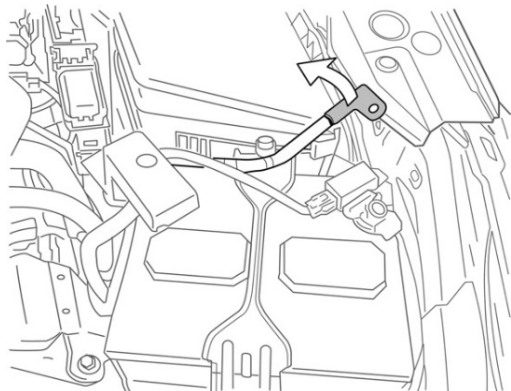

Step 3: Remove driver side courtesy lamp from cavity in LH side cargo panel. Remove connector from courtesy lamp.

Step 4: Using trim tool detach clips and remove OE cargo sill.

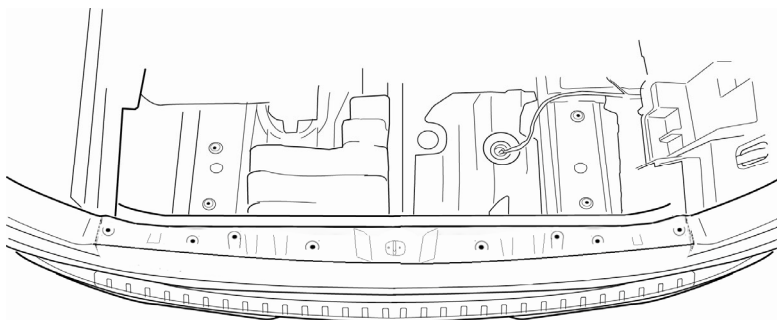
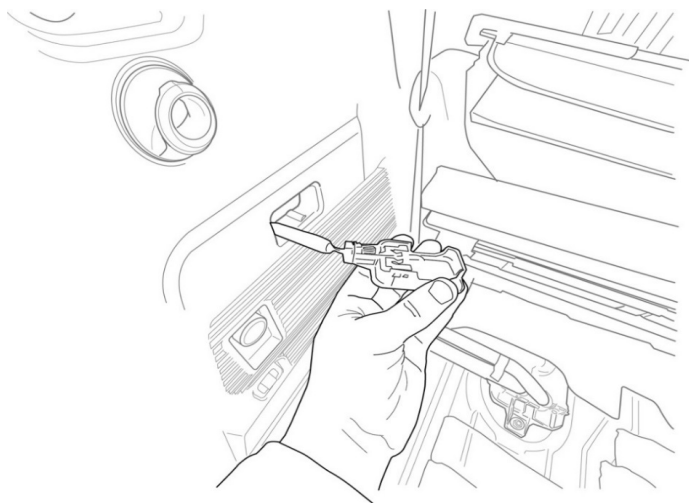



Step 5: Uncover and remove fastener located in D-ring cavity in LH side cargo panel.

Step 6: Remove fastener located above the courtesy lamp on LH side cargo panel. Remove cover with trim tool to access the screw.

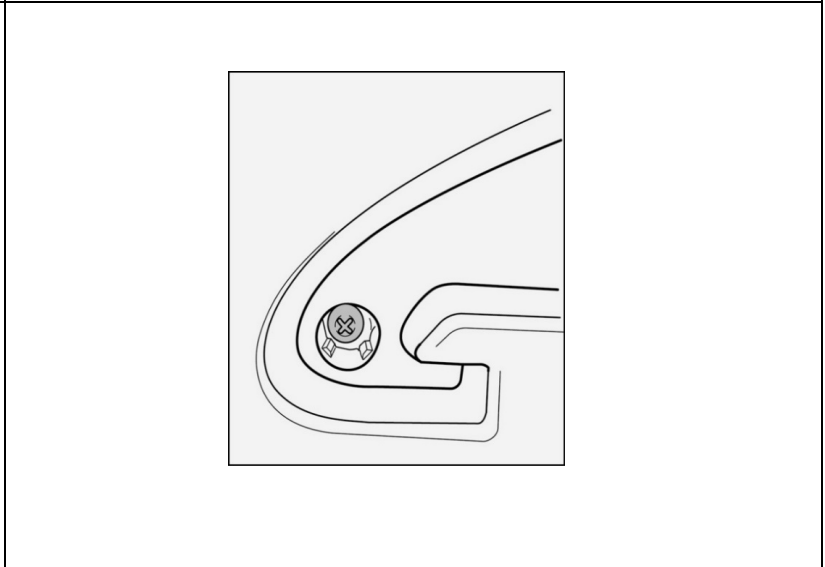
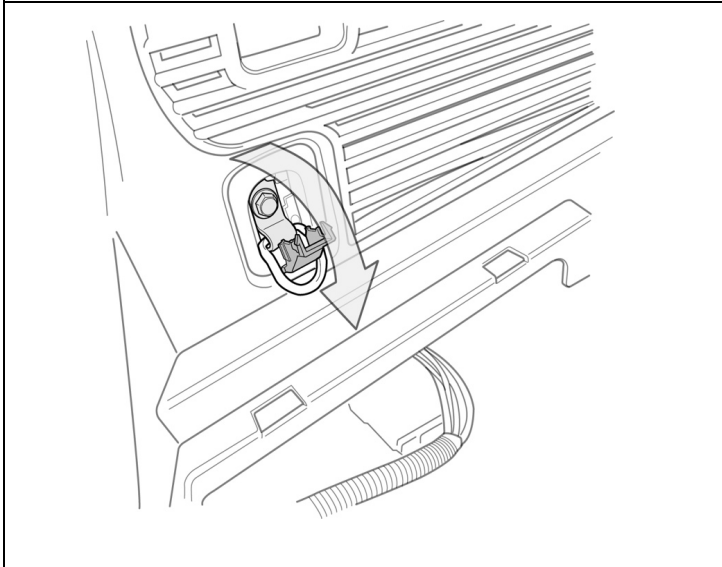

Step 7: Using the trim tool, disengage the clips securing the LH cargo panel to reveal courtesy lamp power connector.

Step 8: Lay illuminated Cargo Sill on cargo floor. Attach the female harness connector to vehicle power that was originally connected to the lamp.

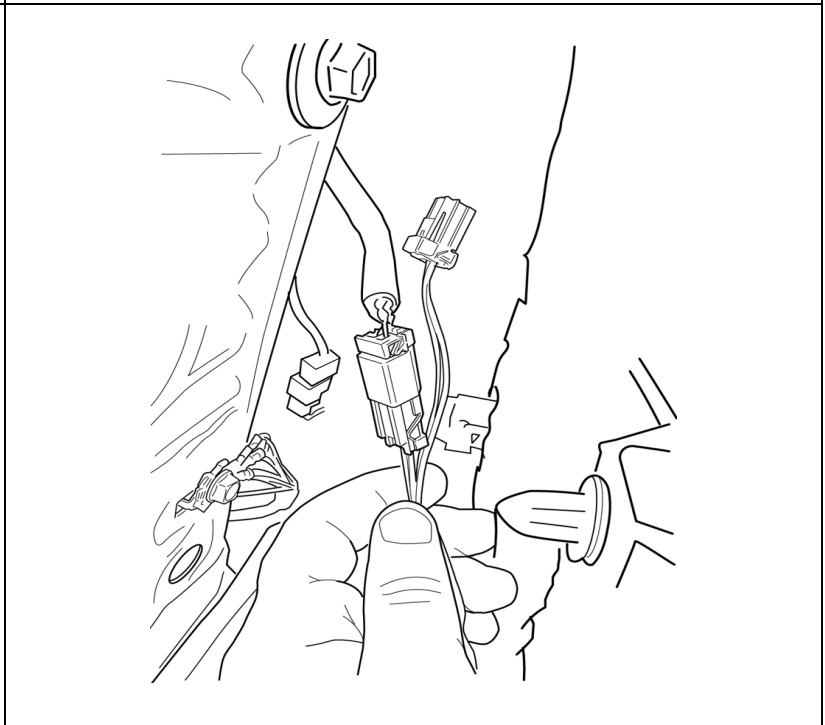
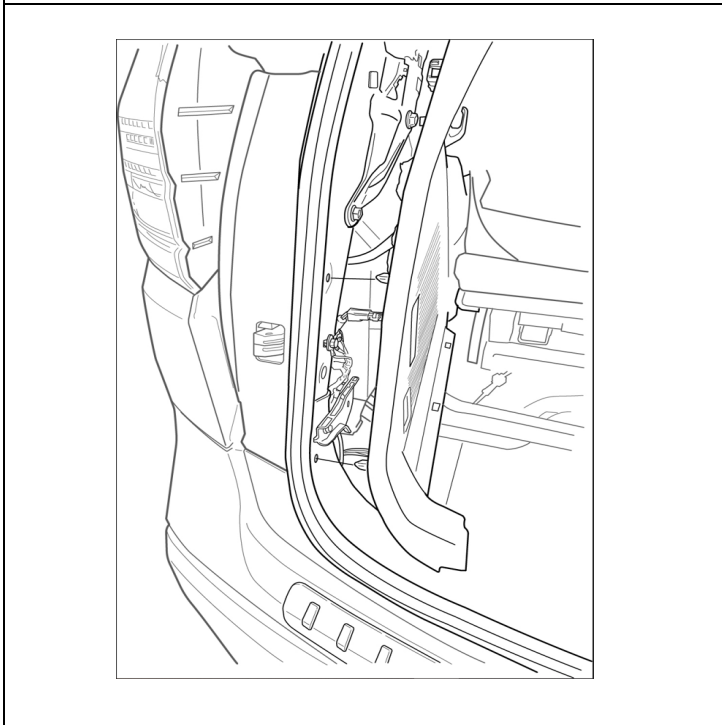

Step 9: Wrap connector with foam tape.

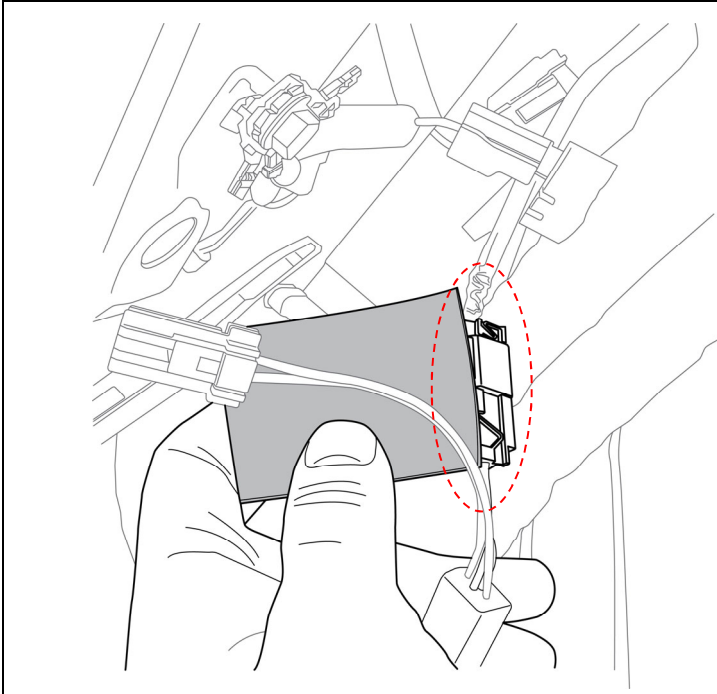

Step 10: Reinsert the courtesy lamp into lamp cavity and attach the male connector.

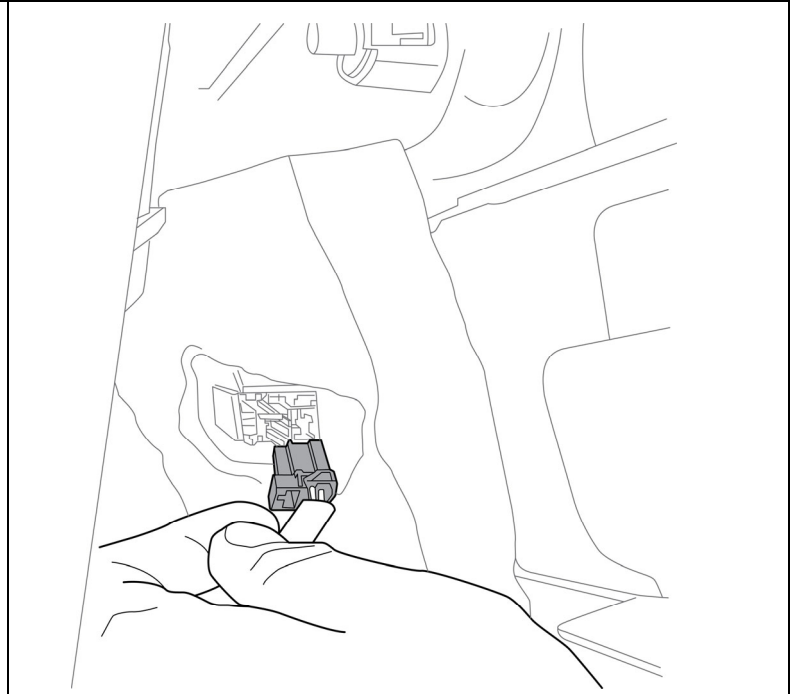

Step 11: Secure the harness to the back side of the LH cargo panel using foam tape.

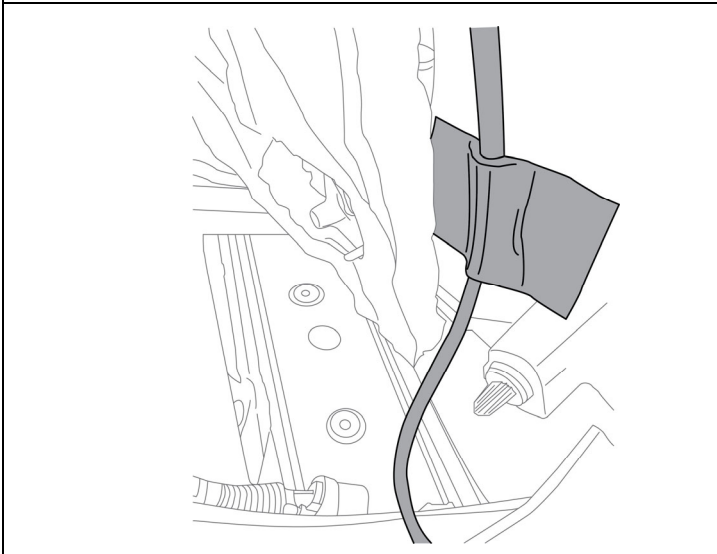

Step 12: Reattach LH cargo panel with (x2) attachment clips seated properly. Reinsert upper and lower fasteners (x2).

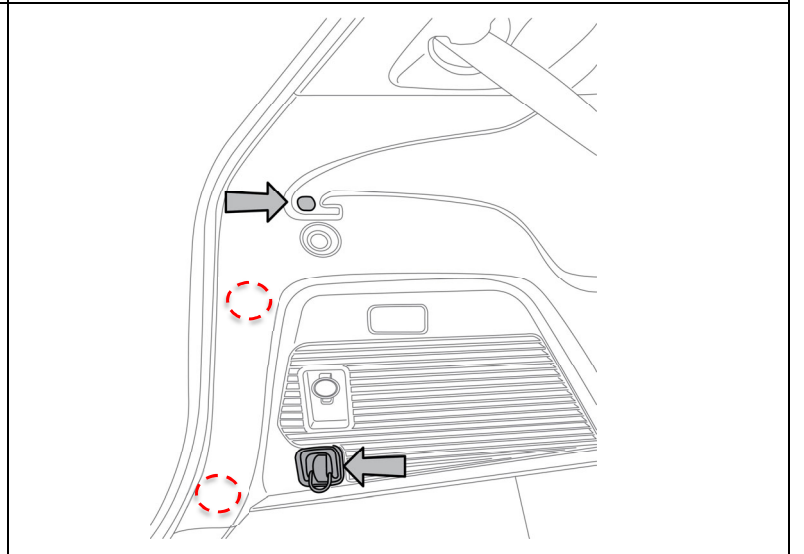

PART NUMBER:
H461SXC300

ISSUE
00

9/5/2023

SUBARU OF AMERICA

PAGE 4 / 5



Step 13: Route harness as shown to avoid pinch by cargo panel.

Step 14: Attach Illuminated Cargo Sill to vehicle with (x4) mating clips by applying even pressure.

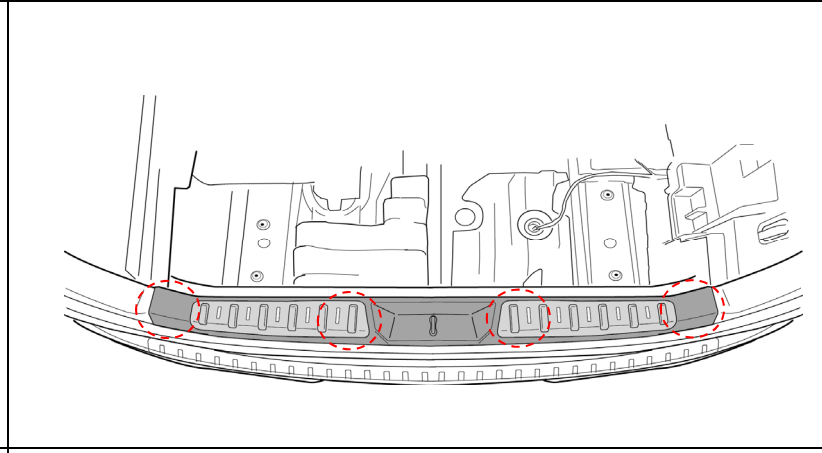
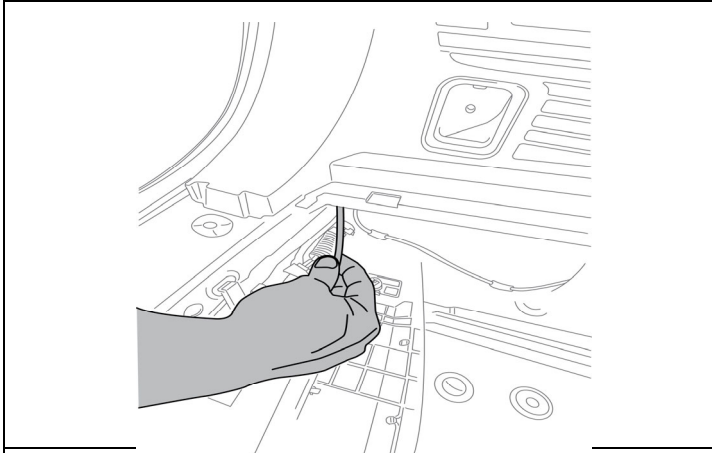

Step 15: Seal any pinched weather strip with trim tool or by hand.

Step 16: Reconnect vehicle battery. Replace all other cargo contents or accessories and reassemble the vehicle.

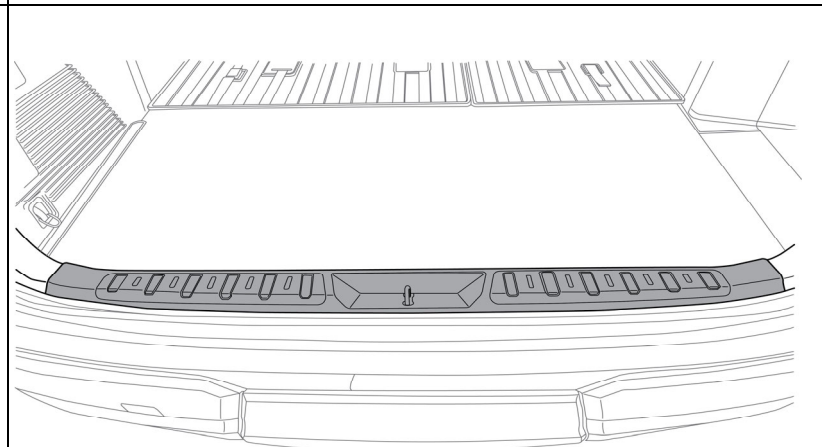
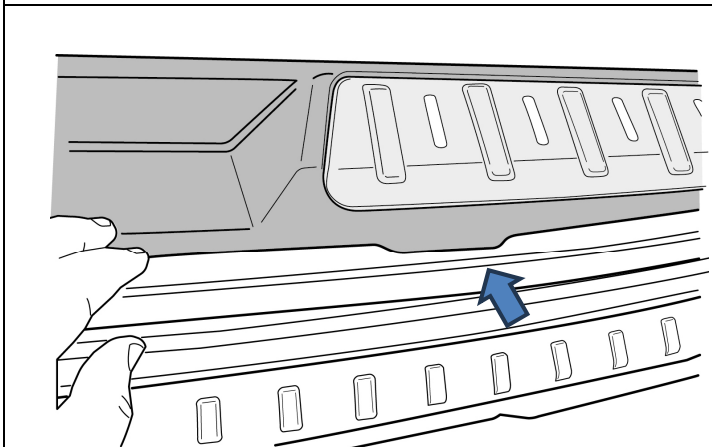

PART NUMBER:
H461SXC300

ISSUE
00

9/5/2023

SUBARU OF AMERICA

PAGE 5/5