

# 2022MY BRZ Interior Auto Dimming Compass Mirror Port Installation Instructions

 Ensure the VIN matches the workorder and the vehicle date is in the lock period and there are no “Holds” on the vehicle for any reason. Ensure the vehicle calls for the accessory installation.



Part Number: H501SCC000



**CAUTION: ACCESSORY INSTALLATIONS PERFORMED BY UNTRAINED PERSONS COULD RESULT IN SERIOUS INJURY TO THOSE PERSONS OR TO OTHERS.** Subaru Work Instructions are intended for use by professional accessory installers ONLY. They are written to provide step by step accessory installation instruction for a fast-paced production environment. Properly trained accessory installers have the equipment, tools , safety instructions and know-how to do the job correctly and safely. Included in this information are the use of “special” accessory installation fixtures and templates that are not available to the Retailers or general public. Please refer to the Retailer Installation Instructions found in Subaru Tech Info System (STIS).

**SUBARU OF AMERICA, INC. IS “ISO 14001 COMPLIANT”**  
The international standard for excellence in Environmental Management Systems. Please recycle or dispose of automotive products in a manner that is friendly to our environment and in accordance with all local, state and federal laws and regulations.

# 2022MY BRZ Interior Auto Dimming Compass Mirror Port Installation Instructions

Inspect the Interior Mirror Kit parts to ensure no missing parts or part defects:

## Kit Contents

- A) AD Mirror
- B) Wire Harness Cover
- C) Jumper Wire
- D) Wire Tie
- E) Foam Tape
- F) Owner's User Guide

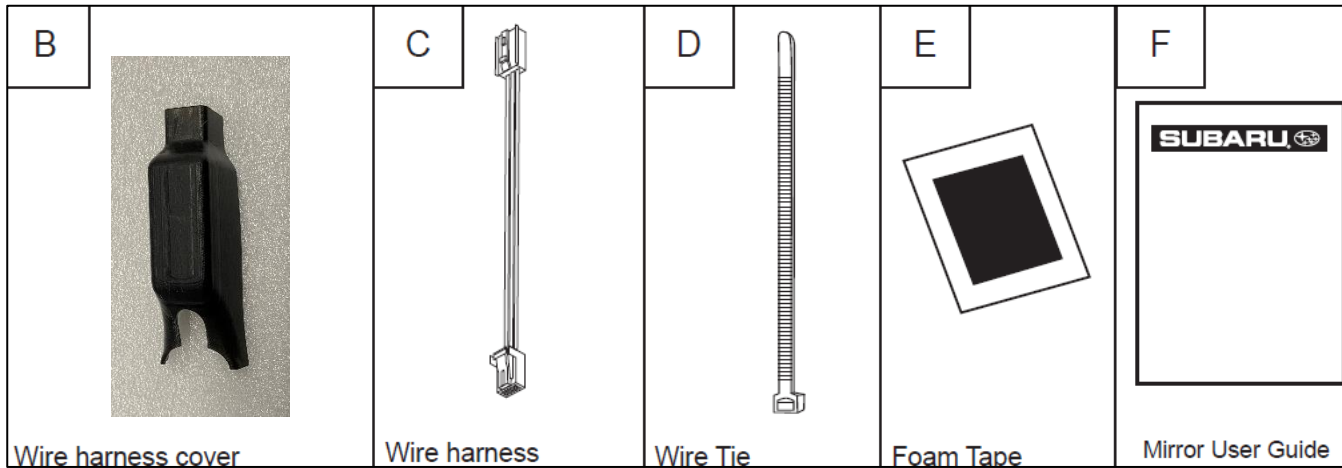

**STOP** **Stop:** Damage may occur to the vehicle/part. Do not proceed until process has been complied with.



**WHA** **Work Hazard Analysis (WHA):** Operator safety-Use caution to avoid risk of injury.



**Caution:** A process that must be carefully observed in order to reduce the risk of damage to the accessory/vehicle and to ensure a quality installation.



**Revision Mark/Highlight:** This mark highlights a change in installation with respect to the previous issue.



**WIT** **Work Instruction Training (WIT):** Key point that designates an important step to ensure the quality of the installation.



**Recycle:** Item to be recycled.



**Safety Torque -** This mark indicates that a torque is related to safety

# 2022MY BRZ Interior Auto Dimming Compass Mirror Port Installation Instructions

## Required Tools and Supplies

- Torque screwdriver with (in. lbs.) with Torx T20 Bit and #2 Phillips Bit
- #2 Phillips Head Screwdriver
- ¼" torque wrench
- ¼" drive ratchet with 10mm and 8mm sockets
- ¼" drive 6" extension
- Nylon trim tool
- Clean towels
- Window Glass Cleaner (Optional)
- Dash protection
- Masking tape

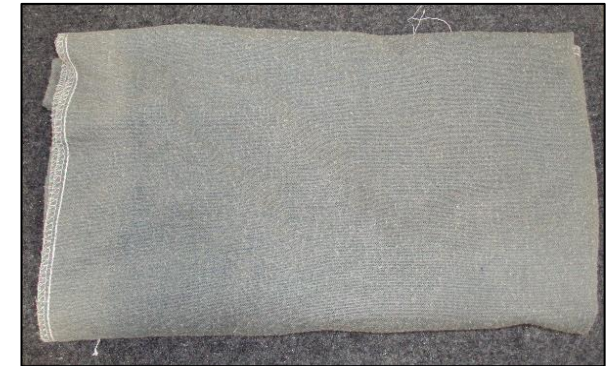

# 2022MY BRZ Interior Auto Dimming Compass Mirror Port Installation Instructions

## Battery Terminal Stud Removal



While disconnecting the negative battery cable from the stud, hold the battery sensor in place with one hand while loosening the 10mm hex nut that secures the cable to the sensor. This will help support the sensor to prevent damage and also prevent the assembly from rotating on the battery post causing a poor connection. ⚠

Open the hood and use the prop rod to hold the hood in the open position. While holding the battery sensor in place with one hand, use a ¼" drive ratchet and 10mm socket to remove the negative battery cable from the negative battery stud. Do not remove negative cable from the battery post. Position / protect the negative cable so it cannot accidentally touch body ground or the negative the battery terminal. Allow (60) seconds before the next installation step to ensure the airbag power supply is discharged.

⚠ Carefully remove the negative battery cable from the battery stud only. Do not allow the negative cable accidentally ground during the installation.

# 2022MY BRZ Interior Auto Dimming Compass Mirror Port Installation Instructions

## Preparation

1. Place protection over the RH or LH side sill/door jam when preparing to perform work inside vehicle. Note: If you are working on the LF side apply the same protection.
2. Place protection center dash and shifter plate trim.

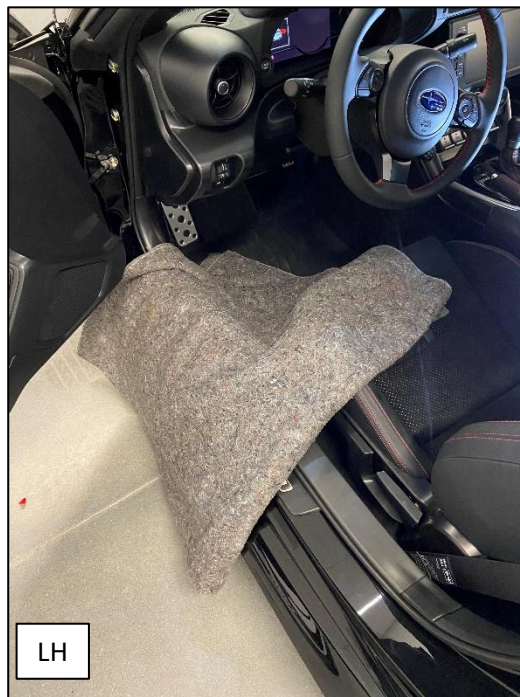

# 2022MY BRZ Interior Auto Dimming Compass Mirror Port Installation Instructions

## Preparation

1. Apply masking tape to the overhead console along the retaining bolt access cover.
2. Apply masking tape to the LH and RH front EyeSight™ camera lens openings when equipped.

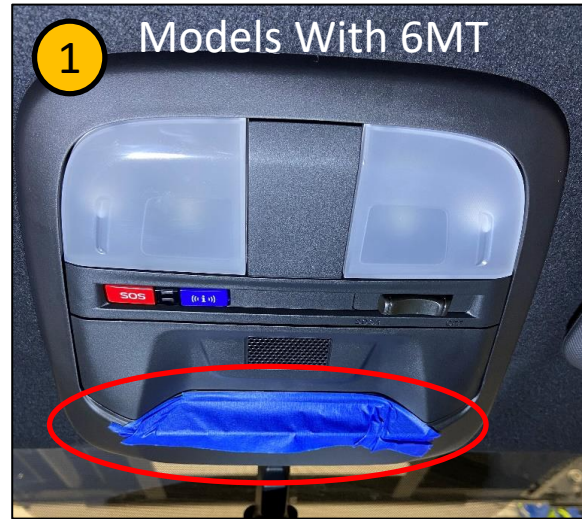

# 2022MY BRZ Interior Auto Dimming Compass Mirror Port Installation Instructions

## Remove the Factory Mirror

1. Remove the O.E. factory installed Interior Mirror by using a trim stick and carefully dislodge the plastic mirror base cover away from the windshield to expose the tab that retain the O.E. Mirror to the windshield.
2. Carefully pull out on the tab and pull up on the O.E. mirror to remove it from the windshield mirror button.
3. Inspect the mirror button for damages.
4. Properly recycle/ dispose O.E. mirror. 



O.E. Mirror

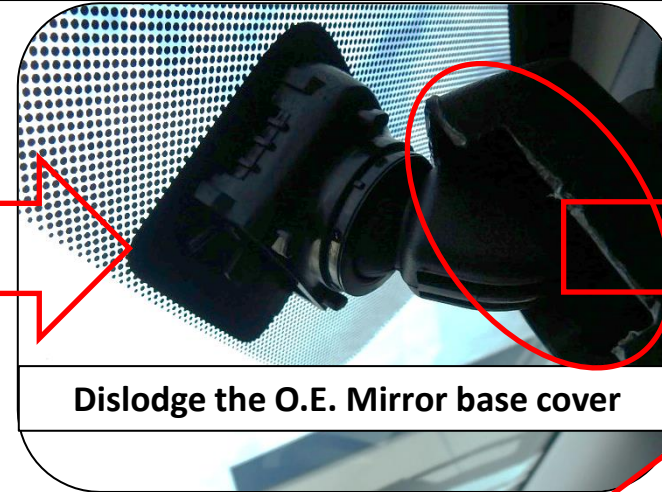
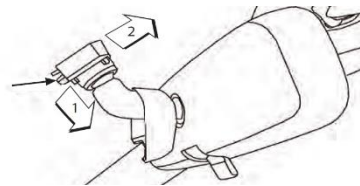

Dislodge the O.E. Mirror base cover

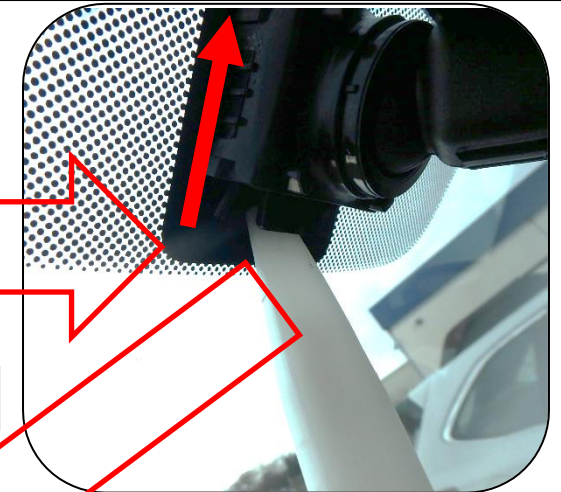

Lift up on Mirror to remove

Using a trim tool pry out on the locking tab



Properly recycle/ dispose O.E. mirror.



Never remove the OE mirror by pulling directly off the windshield under any circumstances. Not following the Manufacturers OEM mirror removal process will result in windshield damage.

# 2022MY BRZ Interior Auto Dimming Compass Mirror Port Installation Instructions

## Interior Auto Dimming Mirror on models with EyeSight™

Slides 8-15



# 2022MY BRZ Interior Auto Dimming Compass Mirror Port Installation Instructions

## Preparation W/EyeSight

1. Using a nylon trim tool, carefully remove the retaining bolt access cover on the overhead console.
2. Using a ¼" ratchet, 6" extension and 8mm socket, Remove (2) 8mm bolts. Save the bolts for reinstallation.



# 2022MY BRZ Interior Auto Dimming Compass Mirror Port Installation Instructions

## Preparation W/EyeSight

1. Place the sun visors in the down position to improve overhead console access.
2. Carefully insert your fingers between the headliner and the overhead console. Disengage the rear retaining clips by applying light downward pressure.
3. Once the rear clips have been unseated, carefully place your hands on both sides of the overhead console and apply light downward pressure to disengage the front clips.

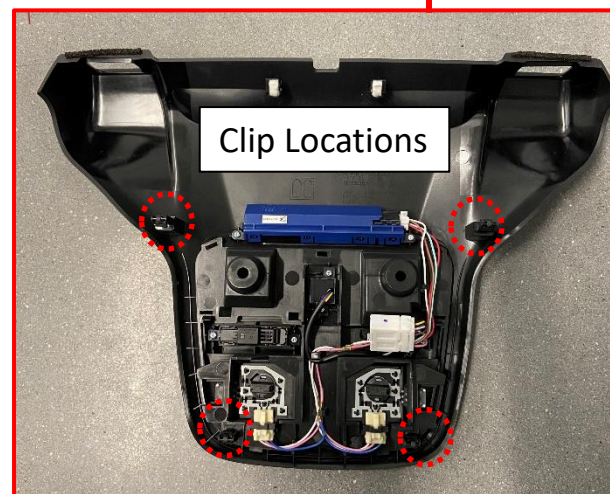
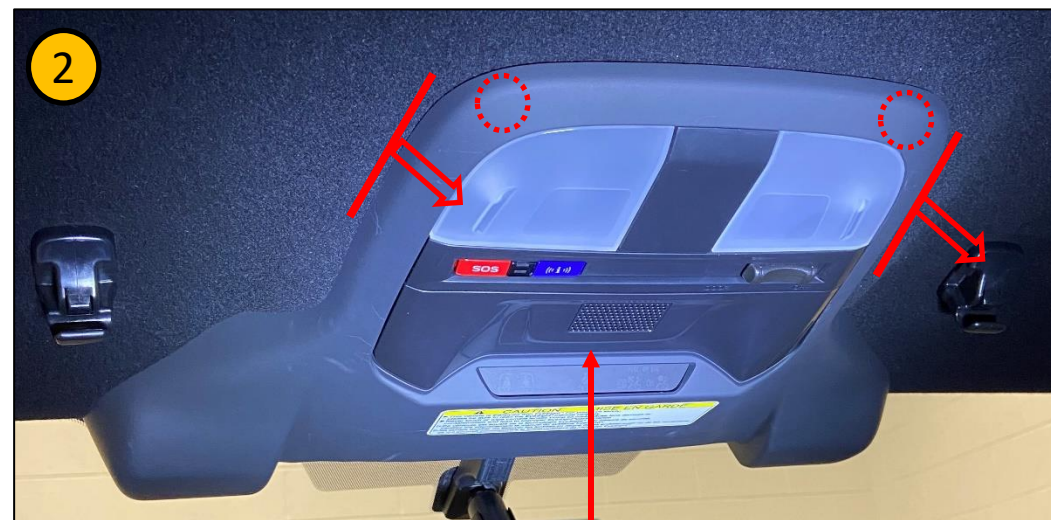

# 2022MY BRZ Interior Auto Dimming Compass Mirror Port Installation Instructions

## Installation W/EyeSight

1. Plug the black connector of the jumper harness into the mirror. (Confirm connection with push-pull method.)
2. Install the wire connector cover.
3. Install the A/D Compass Mirror in place by pushing the mirror down in place over the windshield mirror button.
4. Tighten the T20 Torx screw by using a Torque Screwdriver set to 15.0-inch lbs.

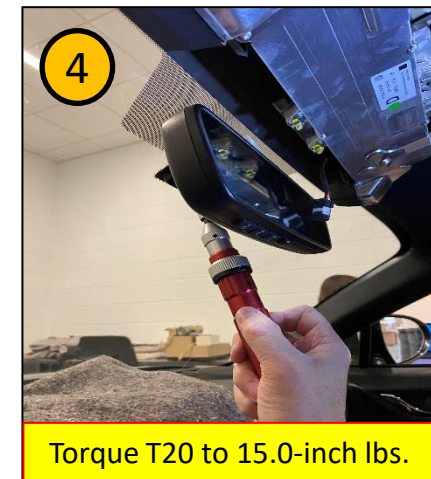
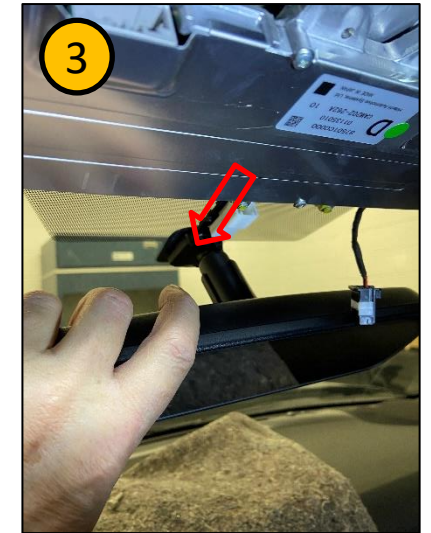

# 2022MY BRZ Interior Auto Dimming Compass Mirror Port Installation Instructions

## Installation W/EyeSight

1. Once all overhead console clips are free, slide the console forward to free it from the front cover hook.
2. Lower the overhead console and disconnect the (2) connectors. Set the overhead console aside on a clean protected surface.
3. Feed the mirror jumper harness around the right side of the EyeSight camera, keeping the black connector on the mirror side.

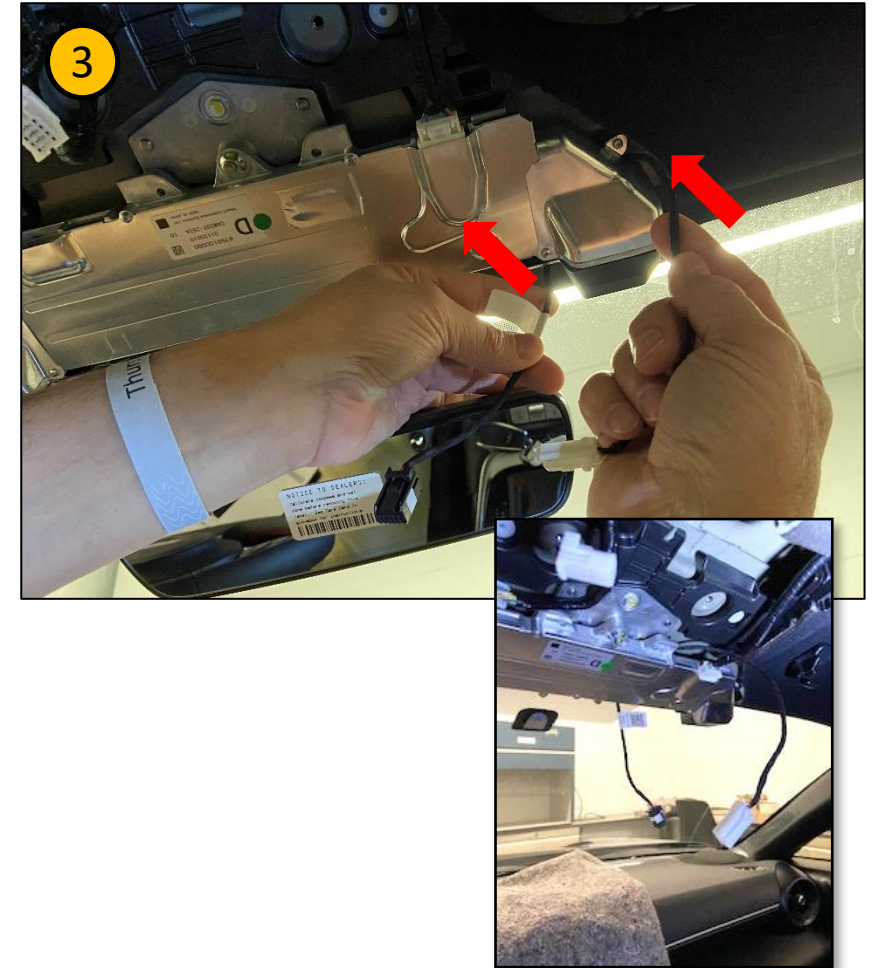
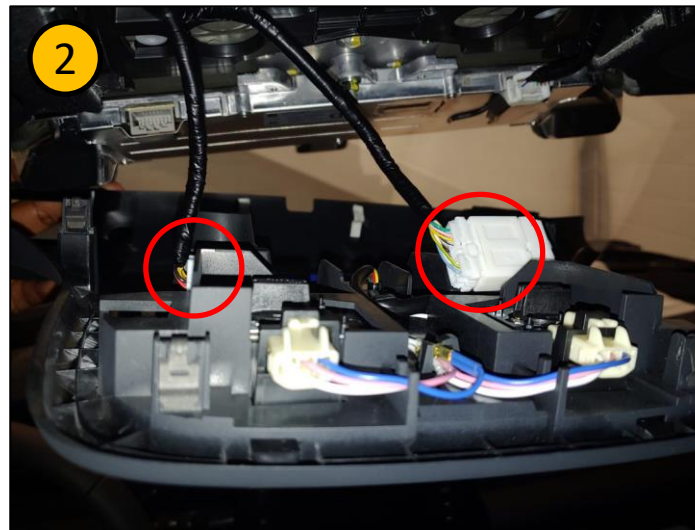

# 2022MY BRZ Interior Auto Dimming Compass Mirror Port Installation Instructions

## Installation W/EyeSight

1. Carefully pull down on the headliner trim while feeding the white connector overtop.
2. Plug the white connector of the jumper harness into the OE mirror connector in the location shown. (Confirm connection with push-pull method)
3. Tuck connectors up in headliner and route the jumper harness as shown. (Position any excess jumper harness slack up in headliner near OE connector) Secure mirror harness to OE harness with a wire tie at the indicated location and cut off excess.

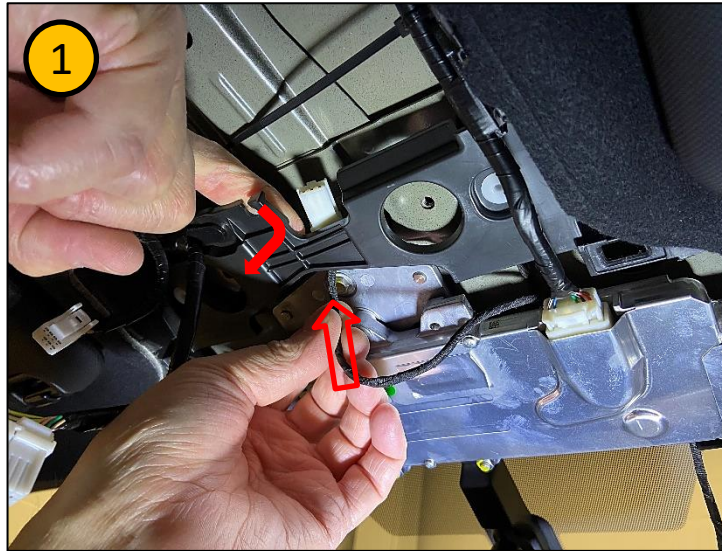

OE connector with Pink breakaway tape.

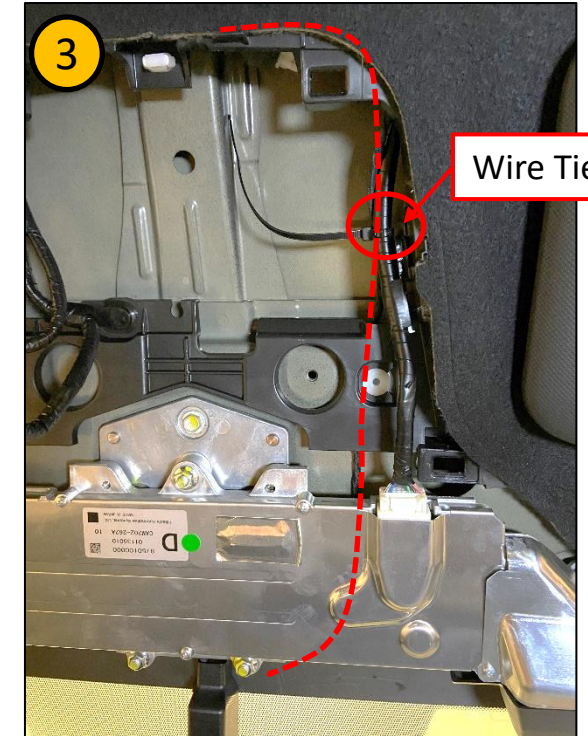

Wire Tie Location

# 2022MY BRZ Interior Auto Dimming Compass Mirror Port Installation Instructions

## Reassemble W/EyeSight

1. While holding the overhead console in one hand, reconnect the (2) OE connectors. (Confirm proper connection with push-pull method)
2. Reinstall the overhead console by aligning the front of the cover to the front hook and slide rearward.
3. Align the (4) console clips and carefully push up on the clip locations to re-seat the overhead console to the headliner.

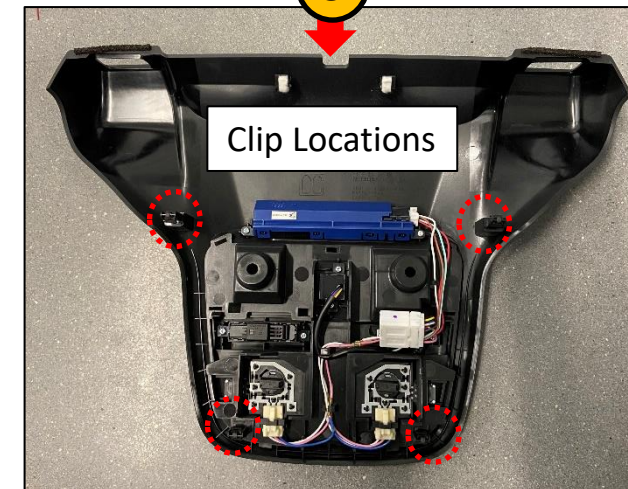
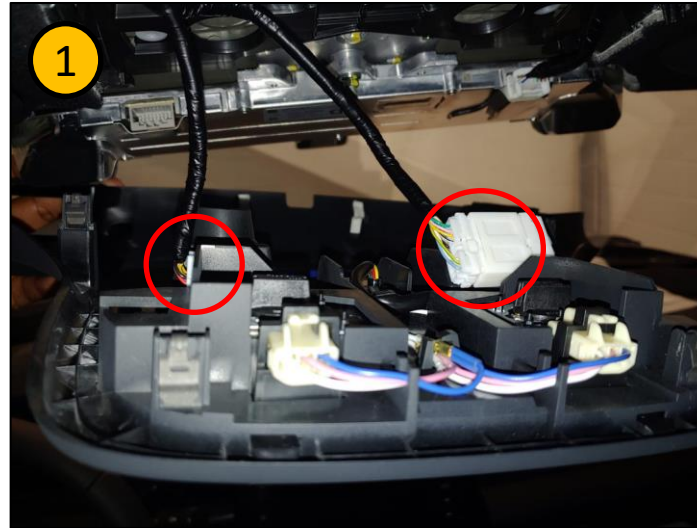

# 2022MY BRZ Interior Auto Dimming Compass Mirror Port Installation Instructions

## Reassemble W/EyeSight

1. Reinstall the (2) 8mm bolts and torque the bolts to 50-inch lbs. (4.0 +/- 0.5 ft. lbs.)
2. Carefully torque mark the bolts.
3. Remove masking tape from the EyeSight™ lens and overhead console.
4. Reinstall the bolt cover panel by inserting the (3) tabs facing the rear of the vehicle first, then push up to engage the front of the cover panel to secure it in place.

➤ Instructions continue Slide #23 on

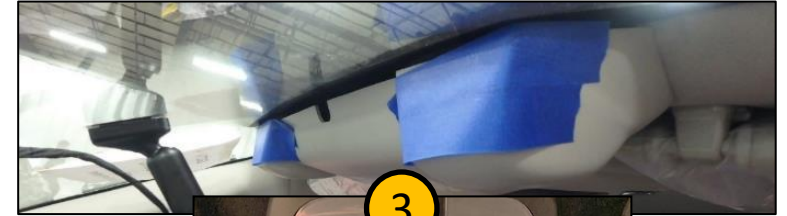

# 2022MY BRZ Interior Auto Dimming Compass Mirror Port Installation Instructions

## Interior Auto Dimming Mirror on models without EyeSight™

Slides 17-22

# 2022MY BRZ Interior Auto Dimming Compass Mirror Port Installation Instructions

## Preparation

1. Using a nylon trim tool, carefully remove the retaining screw access cover on the overhead console.
2. Using a #2 Phillips head screwdriver, Remove (2) screws securing the overhead console to the headliner. (Save the screws for reinstallation)



# 2022MY BRZ Interior Auto Dimming Compass Mirror Port Installation Instructions

## Preparation W/O EyeSight

1. Remove the overhead console by carefully pulling down on the sides to disengage the (2) rear clips.
2. While holding the overhead console in one hand, disconnect (2) electrical connectors.
3. Place the overhead console on a clean protected surface.

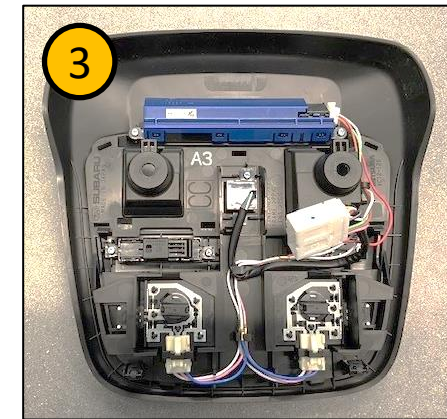
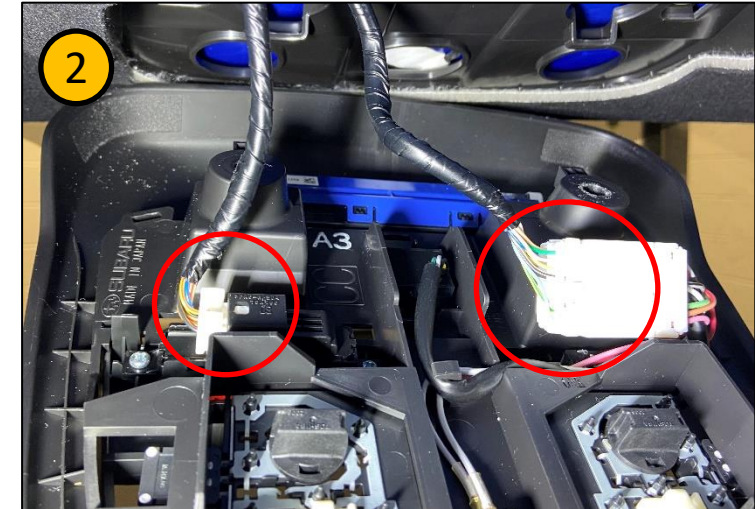

# 2022MY BRZ Interior Auto Dimming Compass Mirror Port Installation Instructions

## Installation W/O EyeSight

1. Carefully pull down on the headliner trim to disengage the (2) headliner trim clips.
2. Feed the jumper harness through the front of the headliner and under the headliner trim.
3. Locate the OE mirror connector
4. Connect the jumper wires white connector to the OE connector. (Confirm connection with push-pull method)
5. Route the jumper harness as shown. Tuck the connector back up in headliner and secure the jumper wire to the roof panel support using the supplied foam tape. Fully reseal the (2) headliner trim clips.

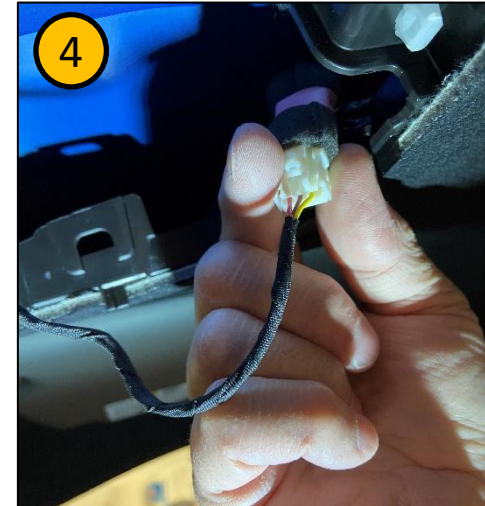
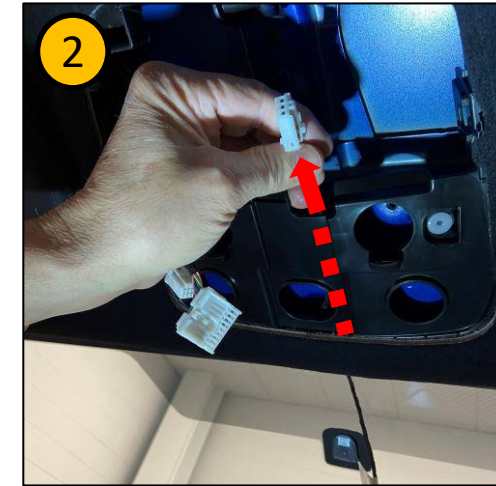
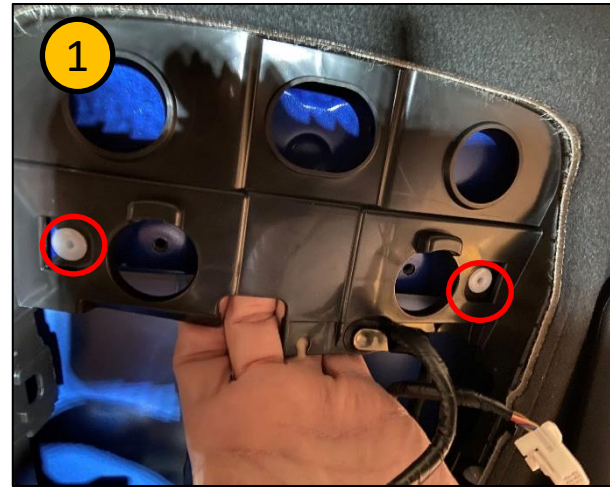

# 2022MY BRZ Interior Auto Dimming Compass Mirror Port Installation Instructions

## Installation W/O EyeSight

1. Plug the black connector of the jumper harness into the mirror.(Confirm connection with push-pull method)
2. Install the wire connector cover.
3. Install the A/D Compass Mirror in place by pushing the mirror down in place over the windshield mirror button.
4. Tighten the T20 Torx screw by using a Torque Screwdriver set to 15.0-inch lbs.

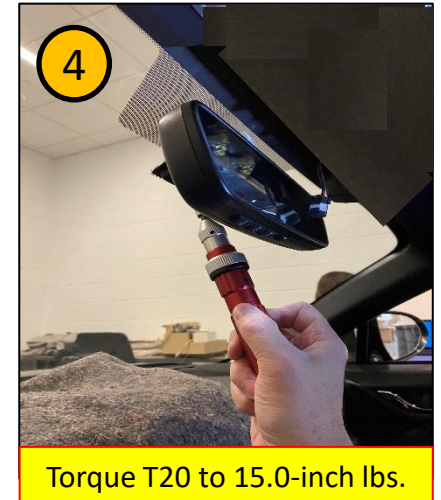
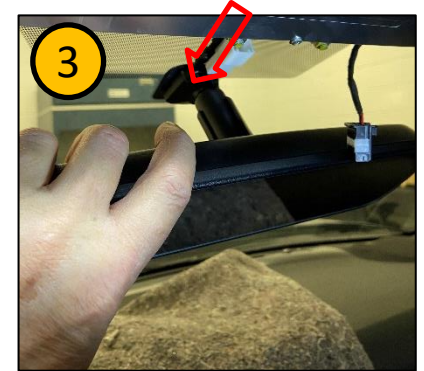
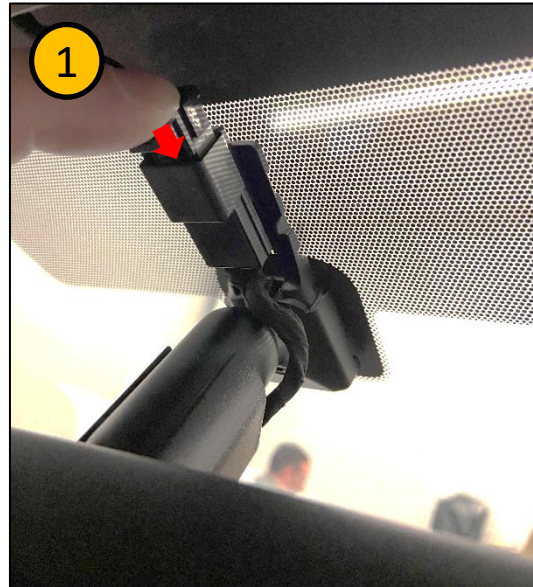

# 2022MY BRZ Interior Auto Dimming Compass Mirror Port Installation Instructions

## Reassemble W/O EyeSight

1. While holding the overhead console in one hand, reconnect the (2) OE connectors. (Confirm proper connection with push-pull method)
2. Aligning the (2) rear console clips and carefully push up on the clip locations to re-seat the rear of the overhead console.
3. Reinstall the (2) screws to secure the console to the headliner. **Do not overtighten**

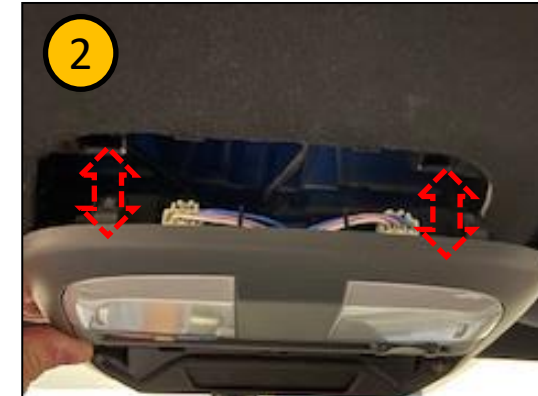
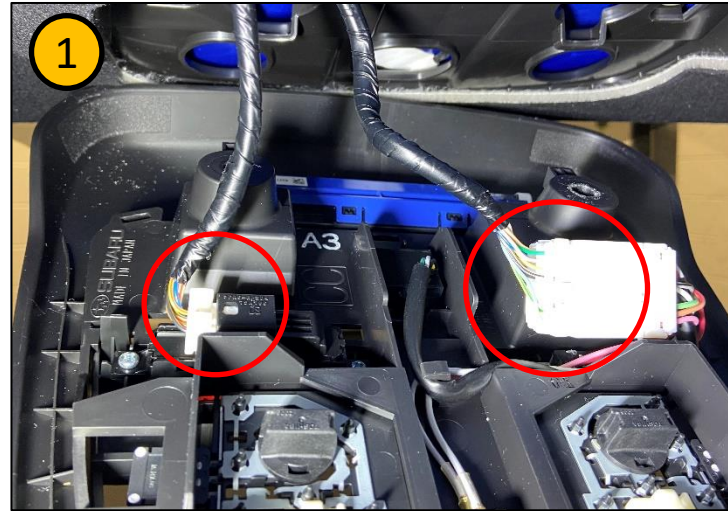

Confirm Harness is clear of clips before seating.



Do Not Overtighten Screws

# 2022MY BRZ Interior Auto Dimming Compass Mirror Port Installation Instructions

## Reassemble W/O EyeSight

1. Reinstall the screw access cover.
2. Remove protective masking tape from around access cover.
3. Reinstall the bolt cover panel by inserting the (3) tabs facing the rear of the vehicle first, then push up to engage the front of the cover panel to secure it in place.



# 2022MY BRZ Interior Auto Dimming Compass Mirror Port Installation Instructions

## Reassemble

1. Remove vehicle protection.
2. Place mirror operation information document in glove box.



# 2022MY BRZ Interior Auto Dimming Compass Mirror Port Installation Instructions



While connecting the negative battery cable to the stud, hold the battery sensor in place with one hand while torquing the 10mm hex nut that secures the cable to the sensor. This will help support the sensor to prevent damage and also prevent the assembly from rotating on the battery post causing a poor connection. ⚠

Re-connect the negative cable by reinstalling the saved 10mm nut on the stud. Use a ¼" drive torque wrench and a 10mm socket, tighten the cable nut to 66 In. Lbs. while holding the sensor to prevent damage and prevent the assembly from rotating on the battery post.

Carefully reinstall the negative battery cable to the battery stud only. Do not allow the negative cable accidentally ground during the installation. ⚠

**Torque mark the battery stud** ⚠



# 2022MY BRZ Interior Auto Dimming Compass Mirror Port Installation

## Instructions

### Check Your Work

- ✔ Ensure the mirror is properly tightened to the windshield. Torque value 15.0-inch lbs. (13.3 – 17.7-inch lbs. ).
- ✔ Ensure the battery negative terminal cable is properly reconnected. (Negative battery stud nut torque 5.5ft-lbs (66 in-lbs.).)
- ✔ Ensure the Bolt / Screw access cover is properly re-installed with no gaps around the panel.
- ✔ Ensure the overhead console cover is properly re-installed with no gaps at the headliner with no damage or chipped edges.
- ✔ Ensure the wiring cover is properly installed straight and the both ends seated properly at the mirror base and around the mirror connector.
- ✔ Turn the Ignition to the “ON” position and cover the interior mirror light sensor and ensure the interior mirror dims accordingly.
- ✔ With your foot on the brake pedal, put the gear selector in “R” mode and ensure the mirror un-dims.
- ✔ Ensure map lights turn on and off, door switch functions on and off and telematics illuminates (w/a).
- ✔ Ensure no soil marks on the head liner, etc. Clean as required.
- ✔ Ensure the mirror glass is clean and the factory sticker is left in place on the mirror

# 2022MY BRZ Interior Auto Dimming Compass Mirror Port Installation Instructions

## Document History

<u>Revision</u>	<u>Date</u>	<u>Slide#</u>	<u>Description</u>	<u>Author</u>
A	8/25/2021	N/A	Original Release	RM