



SUBARU

INSTALLATION INSTRUCTIONS

PART NUMBER: H621SAN000

DESCRIPTION: 2020 Legacy / Outback CD Player

KIT CONTENTS:

CD Player		Side Panels	
Floor Bracket		Inner Console	
Power Harness		Zip Ties (Qty 5)	
Audio Harness		Foam Tape (Qty 2)	
Screws (Qty 6)		Bolts (Qty 2)	
Spring Clips (Qty 6)		Console Mat	
Clips (Qty 2)			



SUBARU

INSTALLATION INSTRUCTIONS

PART NUMBER: H621SAN000

DESCRIPTION: 2020 Legacy / Outback CD Player

TOOLS REQUIRED:

- 10mm & 12mm Socket and Ratchet

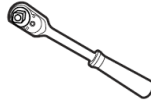

- Torque Wrench



- Philips head screw driver



- Trim Tool





SUBARU

INSTALLATION INSTRUCTIONS

PART NUMBER: H621SAN000

DESCRIPTION: 2020 Legacy / Outback CD Player

1 – Pre-Installation



SUBARU

INSTALLATION INSTRUCTIONS

PART NUMBER: H621SAN000

DESCRIPTION: 2020 Legacy / Outback CD Player

1-1



- Place vehicle in ACC mode
- Engage Parking Brake
- Move Driver/Passenger Seat to Rearmost Position
- Turn vehicle OFF

1-2

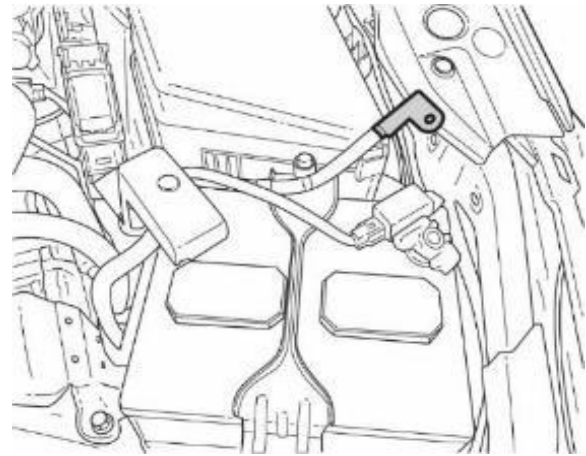

Disconnect Negative (-) battery cable from the battery sensor terminal. Hold the battery sensor carefully when removing the 10mm nut.



SUBARU

INSTALLATION INSTRUCTIONS

PART NUMBER: H621SAN000

DESCRIPTION: 2020 Legacy / Outback CD Player

2 – Dash and Radio Removal

DESCRIPTION
2020 Legacy / Outback CD Player

ISSUE
03

DATE
10/09/2019

SUBARU OF AMERICA

PAGE
5 / 20



2-1



Use plastic trim removal tool to pry and pull up and remove upper dash trim.

2-2



Remove two (2) philips head screws from gauge cowl. Remove cowl by pulling toward you.

2-3



Remove LH side trim panel to access (1) Philips screw. Remove screw. Remove additional screw from right side of lower dash trim panel

2-4



Unclip the LH lower dash trim panel starting from the left side.

2-5



For key-start vehicles, unclip the small panel near the ignition cylinder.

2-6



For push-start models unplug the START switch.

2-7



Using trim tool, release dash pad and remove. Note, release one clip of driver side lower dash to remove pad.

2-8



Remove four (4) 10mm bolts to remove radio from the dash. Release radio by pulling toward you to disengage clips.

2-9

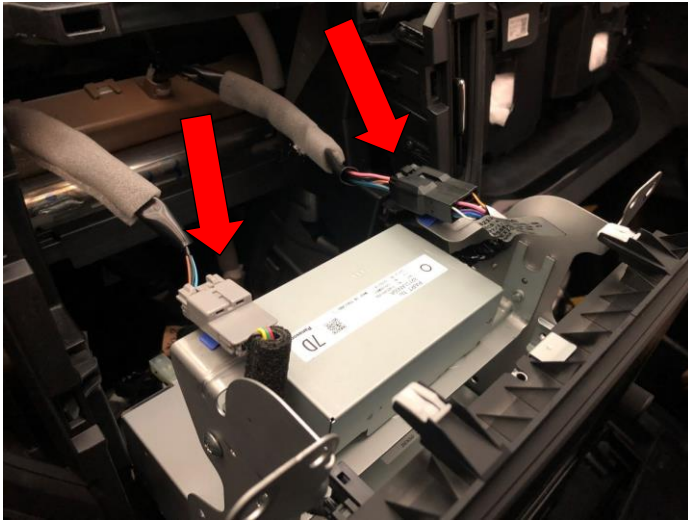

Disconnect two top connectors

2-10



Disconnect all remaining connectors from radio and carefully place unit aside.



SUBARU

INSTALLATION INSTRUCTIONS

PART NUMBER: H621SAN000

DESCRIPTION: 2020 Legacy / Outback CD Player

3 – Center Console Removal



3-1



Use plastic trim removal tool to pry and push down on the factory cover grip.

3-2



Use fingers to push pin clip forward on both sides.

3-3



Pull up to remove OE shift knob.

3-4

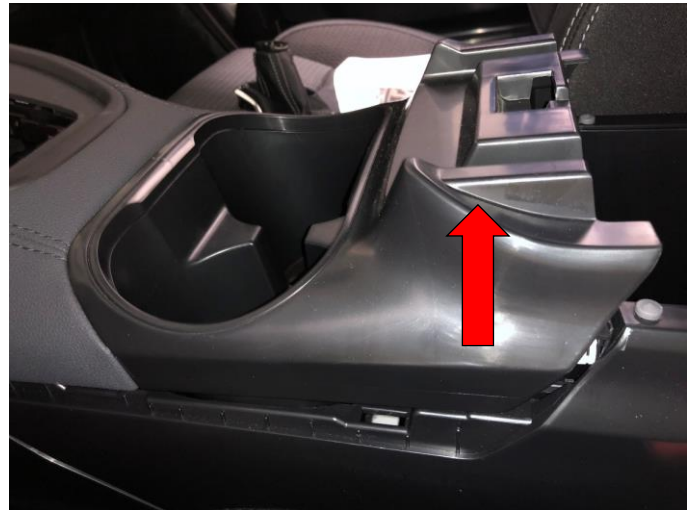

Open Console Lid and Tray
Use plastic trim removal tool, pull up on console cover behind cup holders

3-5

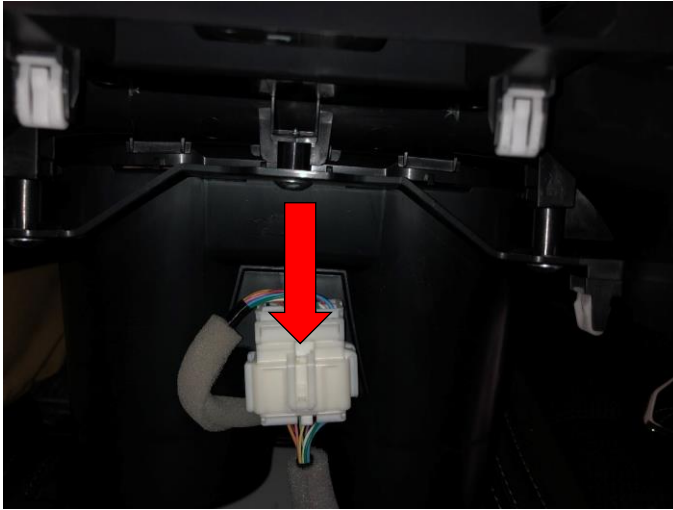

Disconnect console power connection

3-6



Lift towards rearward to remove console cover and place upside down on protected bench top

3-7

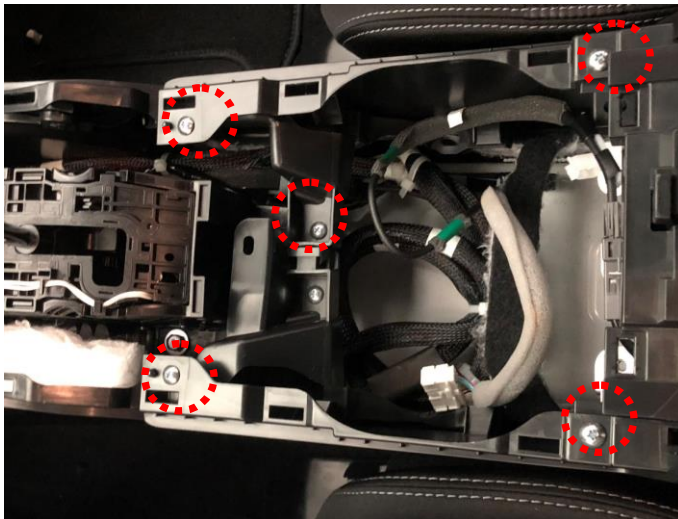

Remove five (5) Philips head screws

3-8



On the driver side of the console box, remove round trim insert and remove 10mm bolt.

Repeat on passenger side.



3-9



From the rear, lift up and remove console box assembly. Place on bench.

3-10

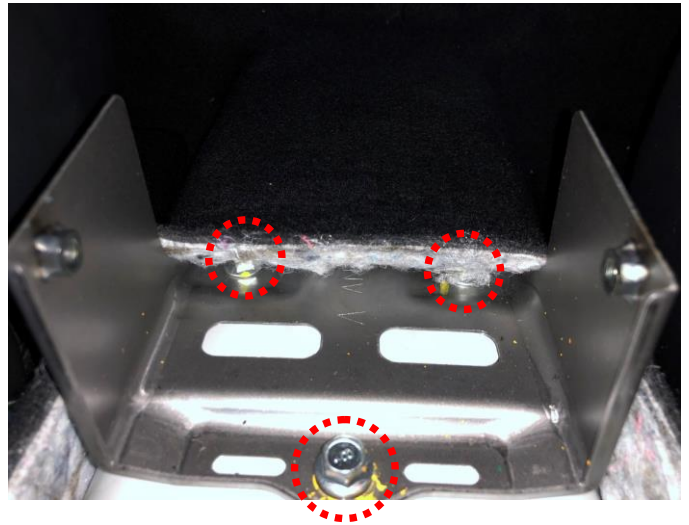

Remove three (3) 12mm bolts and remove floor bracket. Retain bolts for reuse.

3-11

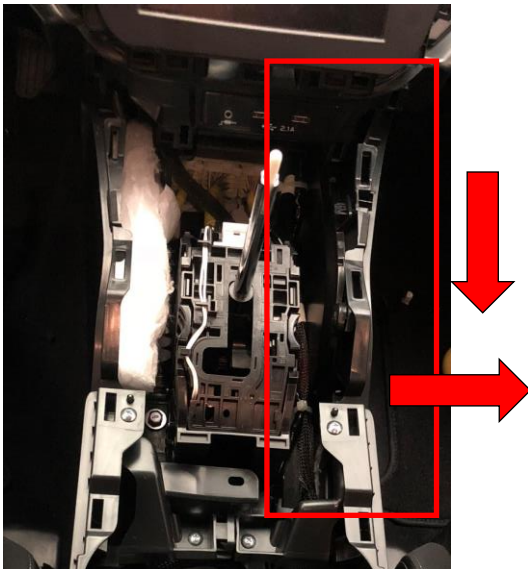

Remove passenger side knee wall by pulling toward the side to disengage center clip then pulling back to remove.



SUBARU

INSTALLATION INSTRUCTIONS

PART NUMBER: H621SAN000

DESCRIPTION: 2020 Legacy / Outback CD Player

4 – Harness Routing

DESCRIPTION
2020 Legacy / Outback CD Player

ISSUE
03

DATE
10/09/2019

SUBARU OF AMERICA

PAGE
13 / 20



4-1

Using the removed 12mm bolts, install the CD player floor bracket and torque to 13.3 ft lbs
Note: ensure forward stud aligns with hole in bracket



4-2

Route power and usb audio harnesses as shown:

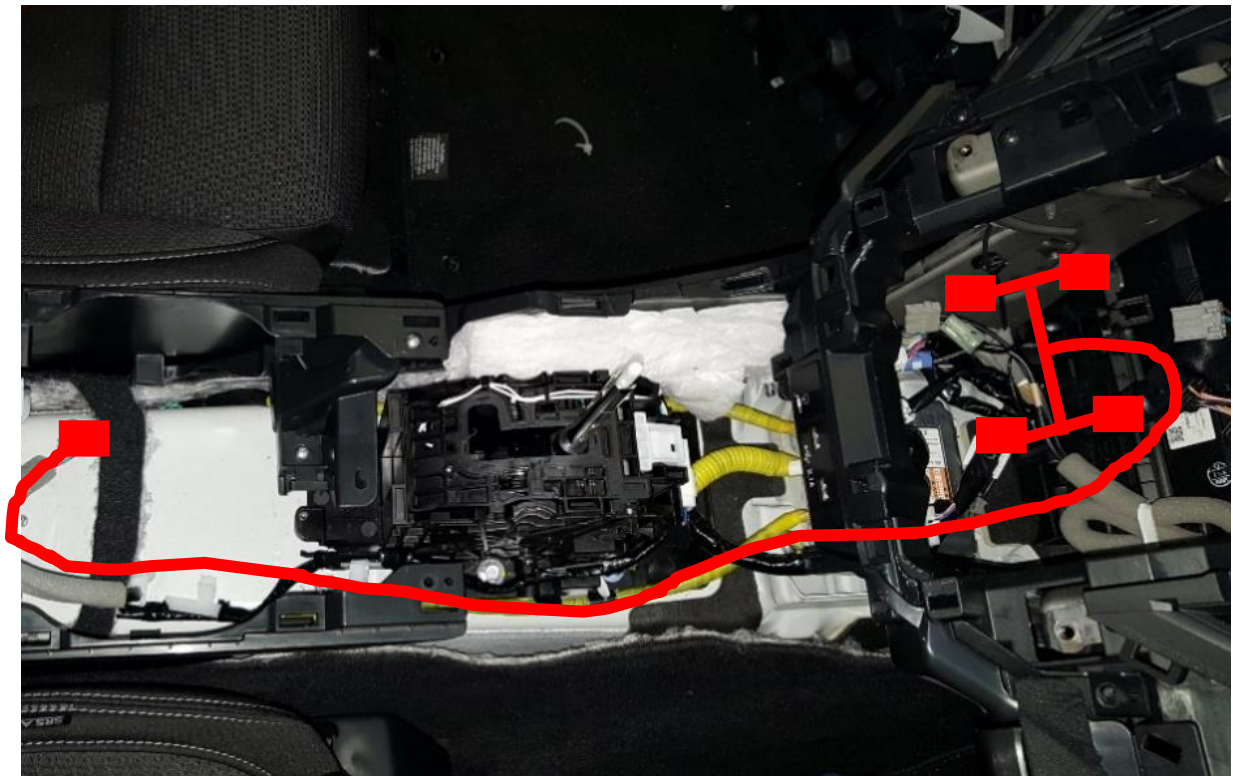

4-3

Install first zip tie in radio cavity.
Ensure both Power and USB cables
are secured to main harness.
Note: leave enough slack for radio
removal and installation



4-4

Secure the power and USB audio harness as shown. Note, tie location 3
uses the preinstalled clip for the audio harness, then a zip tie for the
power harness.

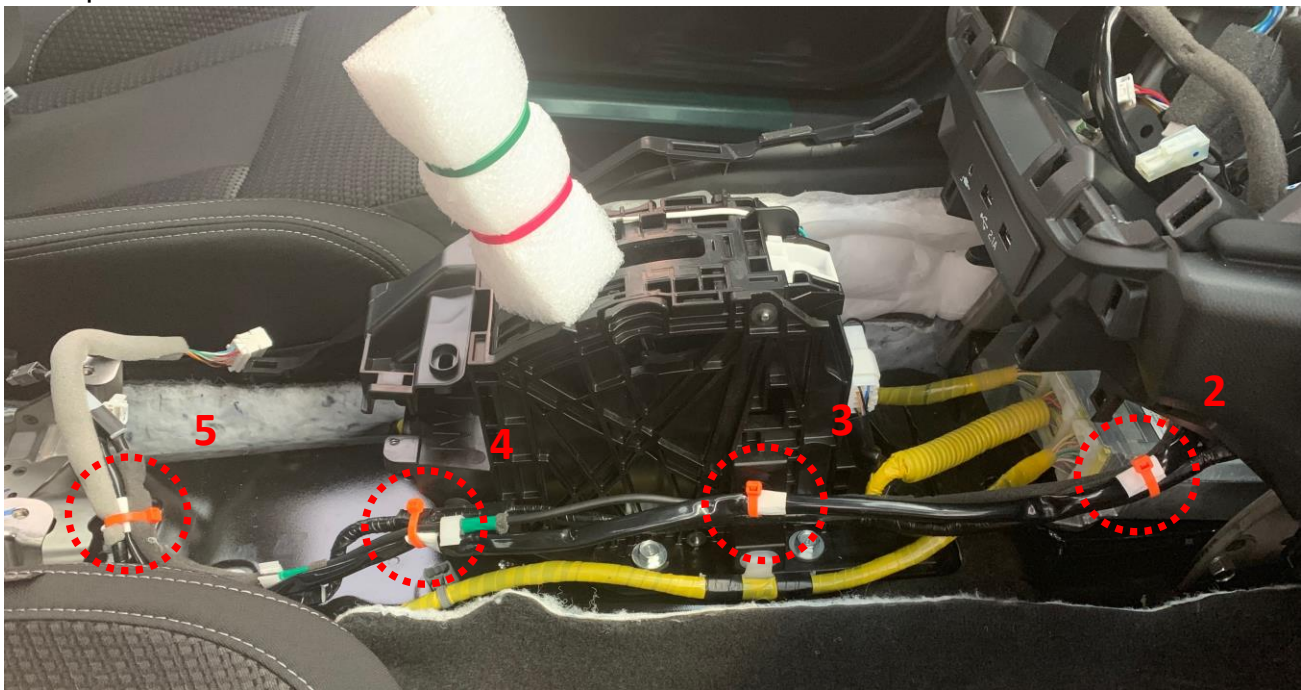

4-5

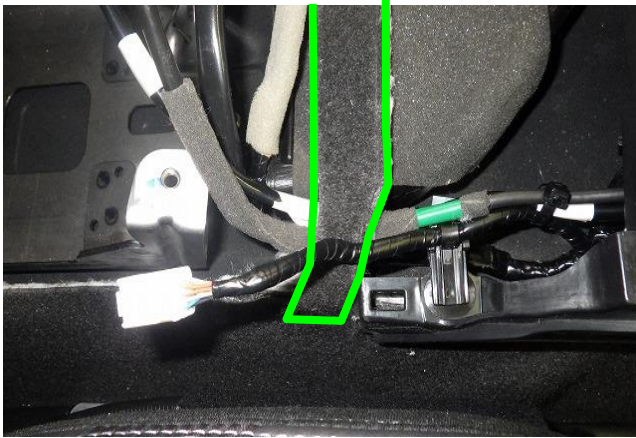

If applicable, ensure the power and audio harness run below the carpet section highlighted above

4-6



Make connections at radio location. Connect the 6-pin and 10-pin connector ends that are wrapped in foam to main two stock radio connectors.

4-7

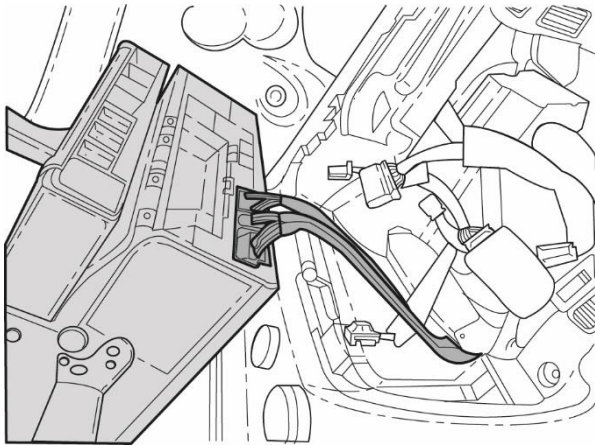

Connect adapter harness, 6-pin and 10-pin connectors to headunit. Reconnect all remaining connectors to radio and telematics module. Reinstall the radio assembly and panels to the dash, A/C vents.

Torque bolts to 5.5 ft lbs



SUBARU

INSTALLATION INSTRUCTIONS

PART NUMBER: H621SAN000

DESCRIPTION: 2020 Legacy / Outback CD Player

5. CD Player Center Console Assembly

DESCRIPTION	ISSUE	DATE	SUBARU OF AMERICA		PAGE
2020 Legacy / Outback CD Player	03	10/09/2019	SUBARU OF AMERICA		17 / 20

5-1



Remove rear panel of center console assembly and place aside for reuse.

If applicable, disconnect rear USB power connector.

5-2



Remove the 6 Phillips head screws. Remove arm rest cover assembly. Place all items aside for reuse.

5-3



On the underside of the center console assembly, slide 6 Spring Clips into place

5-4

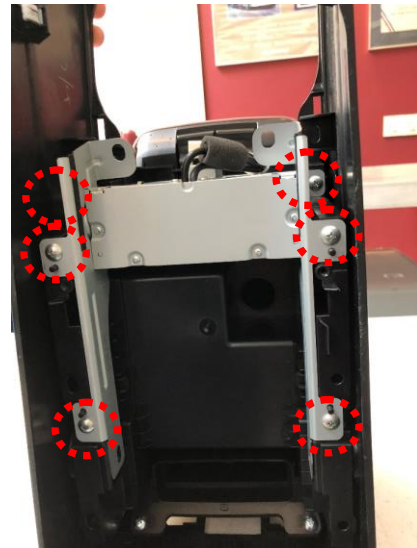

Install CD Player assembly and secure with 6 Phillips head screws

Torque to 16 in lbs



5-5

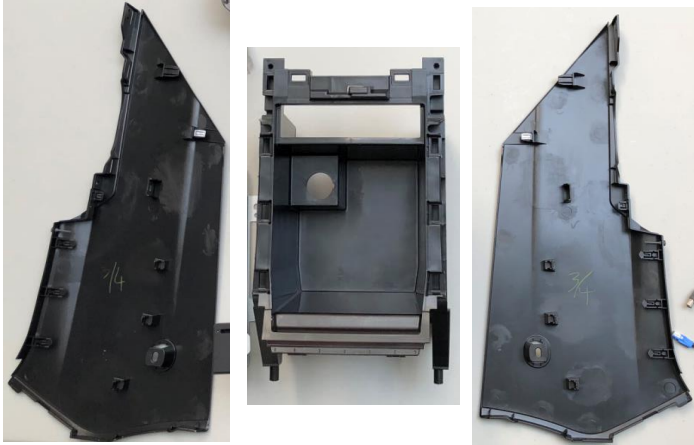

Connect left and right side driver panels to inner console pocket.
Replace rear two screws.

5-6

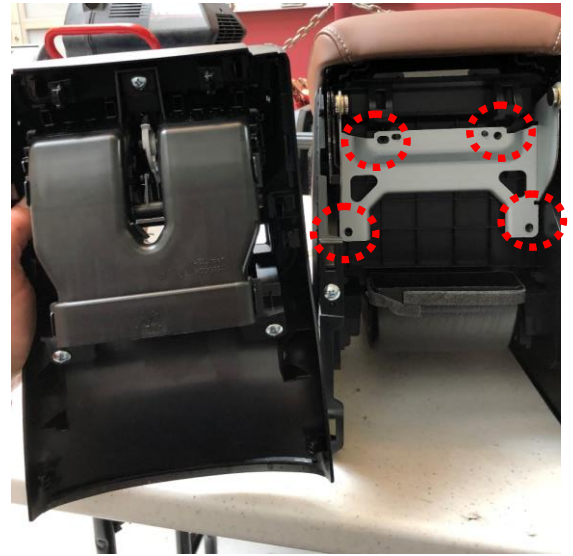

Affix arm rest cover assembly using 4 Phillip's head screws.
Re-attach rear panel
Insert Console Mat into console box
Transfer power port plug from old console to new

5-7



Reinstall console box
Install driver/pass side rear lower bolts (4.8 ft lbs)
Replace trim covers
Replace 5 screws
Install 2 new CD player hold down bolts (5.5 ft lbs)

5-8



Plug in power and audio harnesses

5-9

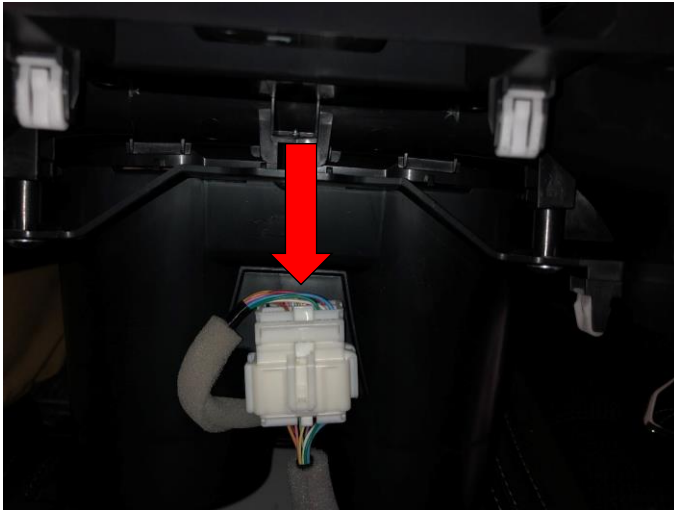

Connect console power connection to console lid

5-10



Reinstall Console Lid and reinstall shift knob.

5-11

Reconnect battery and test audio system for sound at all speaker locations.

